

2026



CAPACITORS



metallized **Film**

Excellence
in Capacitors

AIC EUROPE
Sales & technical support of **AIC** capacitors

Excellence
in Capacitors

AICtech



As a continuation of the 70-year success story written under the Hitachi Group with the brand **HITACHI AIC**, the same players in Japan keep up their passion and quality standards for high-end capacitors under the manufacturer name **AIC tech Inc.**

With a continued spirit of innovation, **AIC tech** remains committed to stay at the forefront of the development and manufacturing of aluminum electrolytic and metallized film capacitors. Due to demanding applications in the automotive market, the topic „humidity impact for film capacitors“ has been dealt with for many years in R&D, with the result of **new standards for the market**, including calculation of the service life depending on relative humidity.

In addition to all the excellent product features, this significant advantage combined with **the Japanese mentality and their zero tolerance** for defects is reflected in the longevity and absolute reliability of AIC capacitors.

Ganz im Sinne der gut 70-jährigen Erfolgsgeschichte, die unter der Hitachi Gruppe mit der Marke **HITACHI AIC** geschrieben wurde, setzen die gleichen Akteure in Japan ihre Leidenschaft und Qualitätsstandards für High-End Kondensatoren unter dem Herstellernamen **AIC tech Inc.** fort.

Mit anhaltendem Innovationsgeist verpflichtet sich **AIC tech** weiterhin, eine Vorreiterrolle bei der Entwicklung und Fertigung von Aluminium Elektrolyt und Film Kondensatoren zu spielen. Durch anspruchsvolle Anwendungen im Automobilmarkt ist das Thema „Luftfeuchte bei Folienkondensatoren“ langjährig in Forschungen und Weiterentwicklungen behandelt worden, mit **Maßstäben für den Markt**, u.a. mit der Berechnung der Brauchbarkeitsdauer in Abhängigkeit von der Luftfeuchte.

Dieser bedeutende Vorteil kombiniert mit der **japanischen Mentalität und ihre Null-Toleranz** gegenüber Fehlern spiegelt sich neben allen hervorragenden Produktspezifikationen auch in der Langlebigkeit und der absoluten Zuverlässigkeit der AIC Kondensatoren wider.

AIC EUROPE



We gratefully look back on over 30 years of general agency for the manufacturer, which is known on the market for one of the lowest field failure rate for many years.

Our decades of experience with capacitor bank configuration in Germany gives us the profound knowledge to select the right capacitor configuration for your application and to overcome side by side with the Japanese product engineers and your own R&D team nearly all technical challenges.

Especially here, the high voltage withstanding and safety functions of our products **continue to set standards in the market.**

In parallel, we reliably supply your worldwide production just in time and master the short-term demands fluctuations through our local safety and consignment stocks as well as through direct contact with the production and logisticians.

All these points make AIC EUROPE your first-class and preferred partner wherever the lifetime of your high-end application depends on the capacitor bank.

Wir blicken mit Dankbarkeit auf über 30 Jahre Generalvertretung für den Hersteller, welcher am Markt mit der niedrigsten Feldausfallrate langjährig bekannt ist.

Unsere Jahrzehnte lange Erfahrung mit der Auslegung von Kondensatoren Bänken verschafft uns das fundierte Wissen, das richtige Bauteil für Ihre Applikation zu finden und Seite an Seite mit den japanischen Entwicklern fast alle technischen Herausforderungen zu meistern.

Gerade hierbei setzen die hohe Spannungsfestigkeit und die integrierten Sicherheitsfunktionen unserer Produkte **nach wie vor Maßstäbe im Markt.**

Gleichzeitig beliefern wir Ihre weltweite Produktion termingerecht und meistern kurzfristige Bedarfsschwankungen durch unsere lokalen Sicherheits- und Konsignationslager sowie durch den direkten Kontakt mit der Produktion und Logistikern.

All diese Punkte machen AIC EUROPE zu Ihrem erstklassigen und bevorzugten Partner, wo immer die Brauchbarkeitsdauer Ihrer Produkte von der Zuverlässigkeit der Kondensatoren Bank abhängt.

> Cylindrically-shaped metallized Polypropylene Film Capacitors
 Zylindrische metallisierte Polypropylen-Folien Kondensatoren

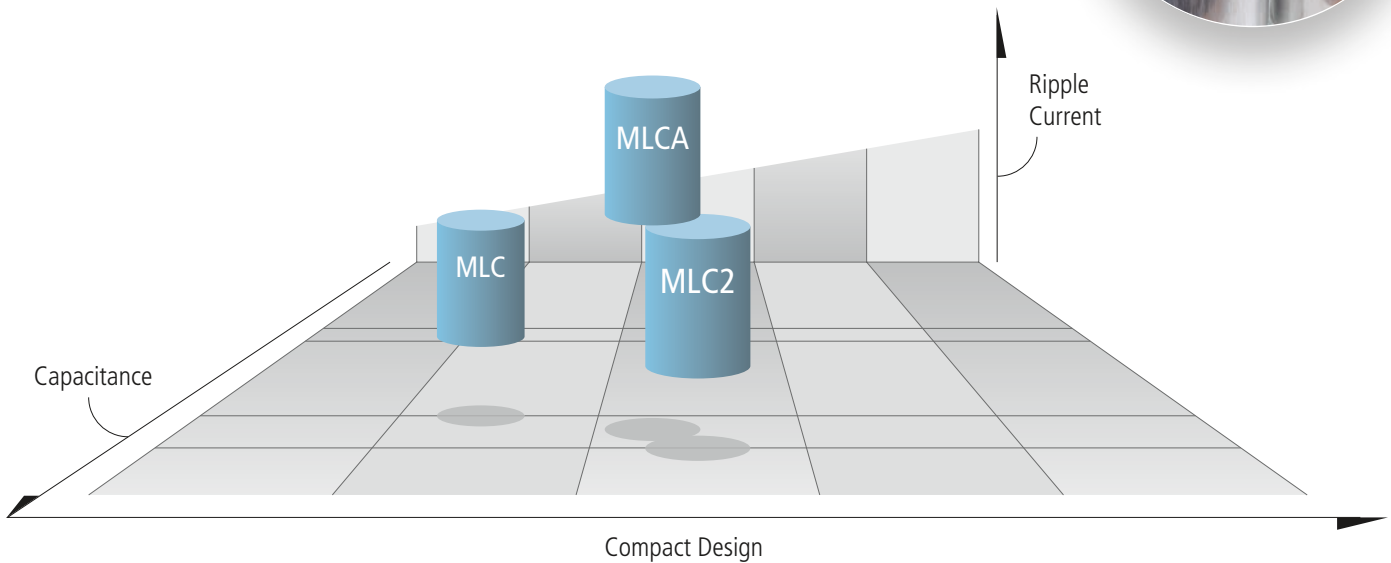

MLC	900V–1500Vdc · -40°C ~ +85°C Standard Performances · Fuse Function · High withstanding voltage design for permanent and deep charge-discharge application	16
MLC2	800V–900Vdc · -40°C ~ +85°C Larger capacitances · Fuse Function · High withstanding voltage design for permanent and deep charge-discharge application	25
MLCA	600V–2200Vdc · -40°C ~ +85°C High ripple current · High voltage	31

> Resin encased Box type metallized Polypropylene Film Capacitors
 Vergossene metallisierte Polypropylen-Folien Kondensatoren

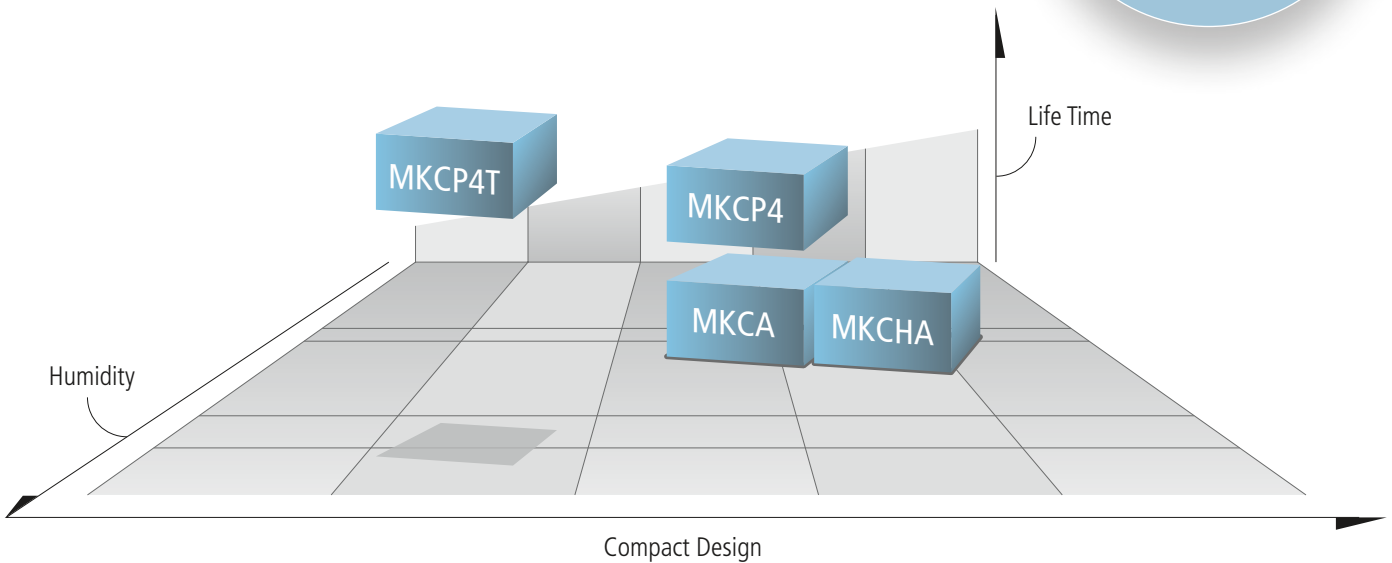
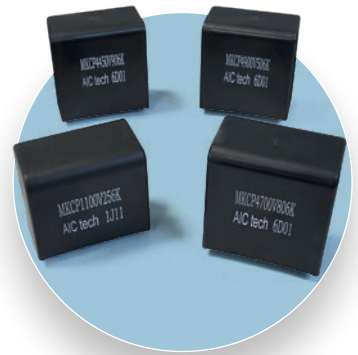

MKCA	450V–1100Vdc · -40°C ~ +105°C Standard Performances	38
MKCHA	450V–1500Vdc · -40°C ~ +105°C Standard Performances	45
MKCP4	450V–1100Vdc · -40°C ~ +105°C High Performances · optional available with Fuse Function and higher withstanding voltage	54
MKCP4T	450V–1100Vdc · -40°C ~ +105°C High-Humidity THB-type (85°C/85% RH – 1000 hrs) optional available with Fuse Function and higher withstanding voltage	59
Handling Cautions		63

Screw-Terminal type

> Outline Drawings and Shape Code · Bauformen und -Code

Shape Code · Form Code: **N = plain bottom**

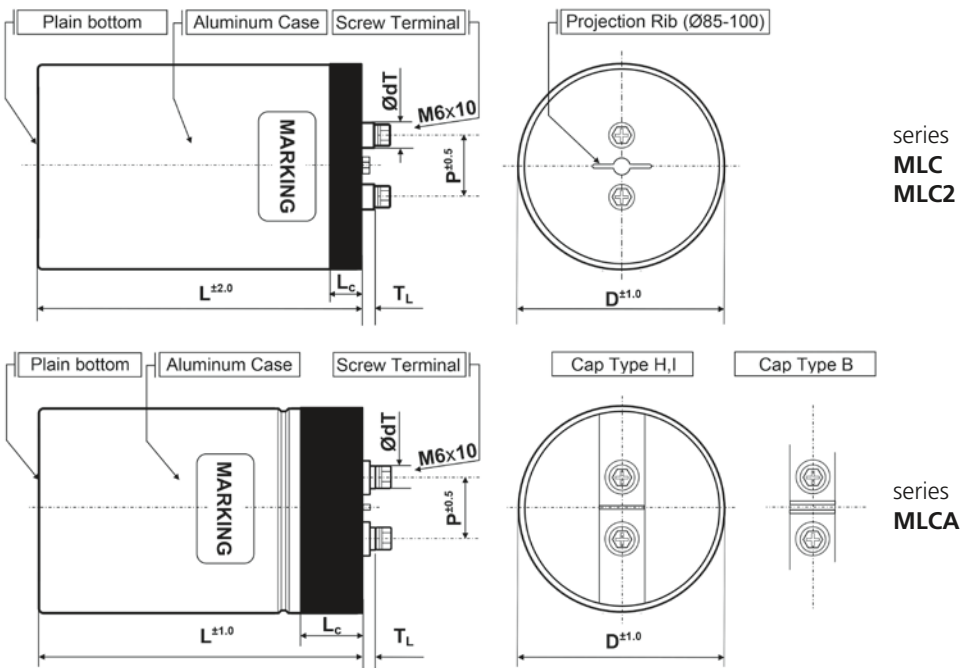

Shape Code · Form Code: **B = stud bolt**

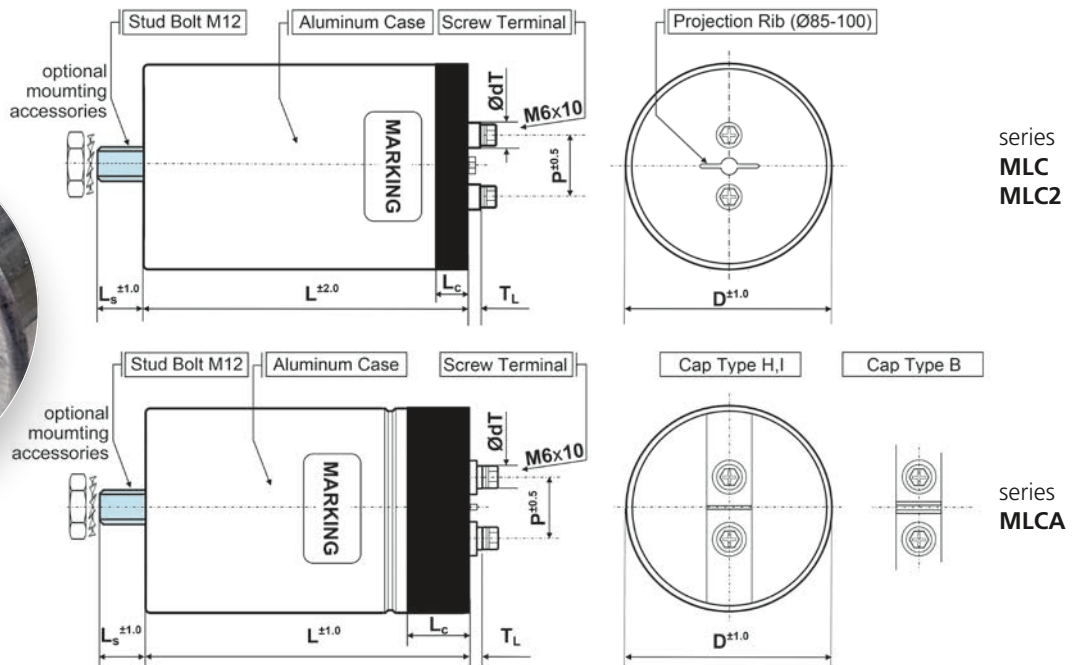

> tightening torques · Anzugsdrehmomente

Tightening torque	Series	Thread	Recommended	Min	Max
Terminal M6	MLC, MLC2	hole depth 10 mm	4.0 Nm	3.5 Nm	4.5 Nm
	MLCA	hole depth 10 mm	4.5 Nm	3.5 Nm	5.0 Nm
Stud Bolt M12	MLC, MLC2	length 16–18 mm	8.0 Nm	6.0 Nm	10.0 Nm
	MLCA	length 16 mm	10.0 Nm	6.0 Nm	12.0 Nm

> Outline Drawings · Bauformen

Shape · Form:	long pin short pin customized	no suffix (standard shape) suffix C suffix S	$T_L = 6.0\text{ mm}^{+0}_{-1.0}$ $T_L = 3.5\text{ mm} - 4.5\text{ mm}^{\pm 0.5}$ specific T_L , $\varnothing d$ or pitch
Safety function · Sicherheitsfunktion:	self healing fuse function	(no suffix) suffix P (not available for MKCA / MKCHA)	

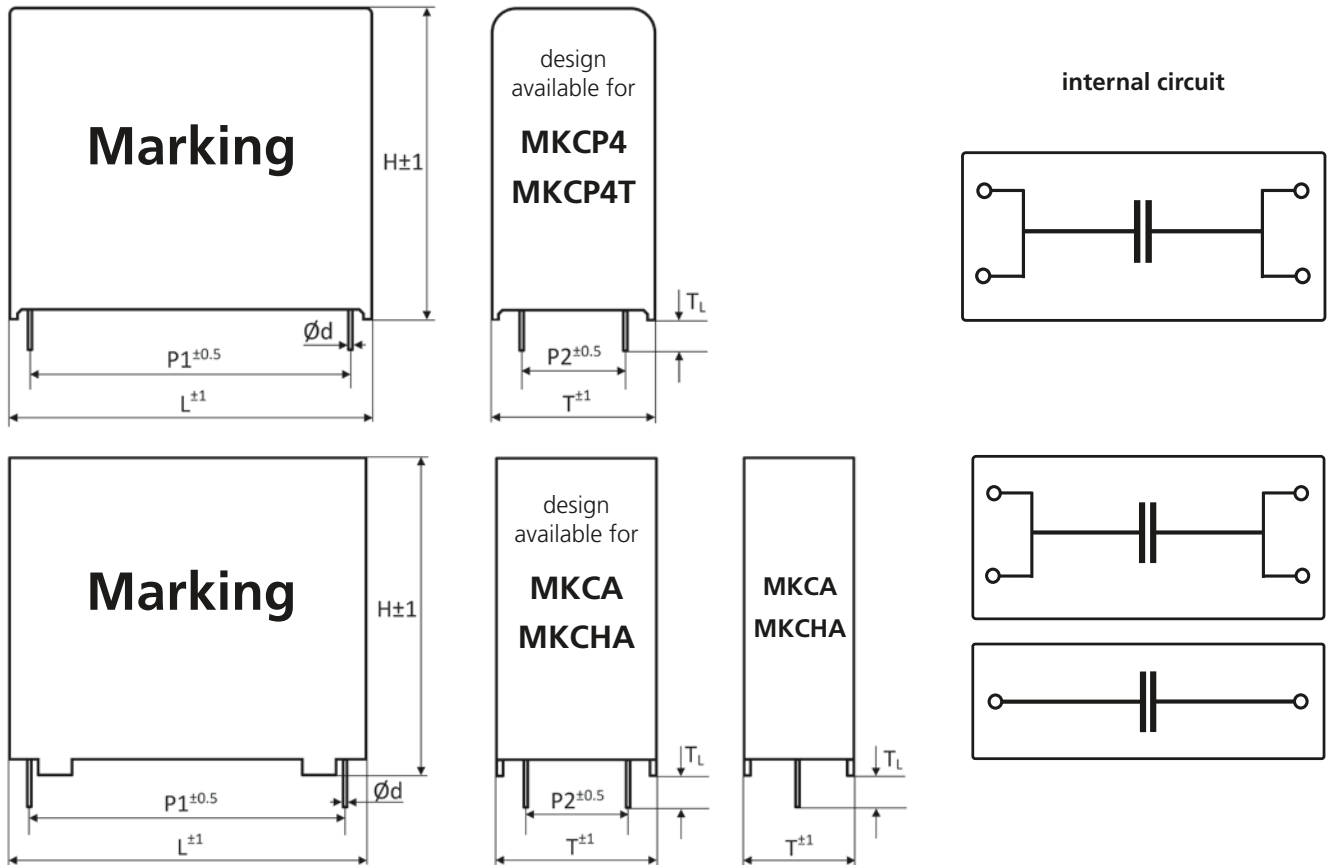

> Soldering Parameters · Lötparameter

- Manual with soldering iron · LötKolben: **Max. 350°C / 3 s**
- Wave soldering · Wellenlöten: **Max. 260°C / 4 s or 250°C / 6 s**

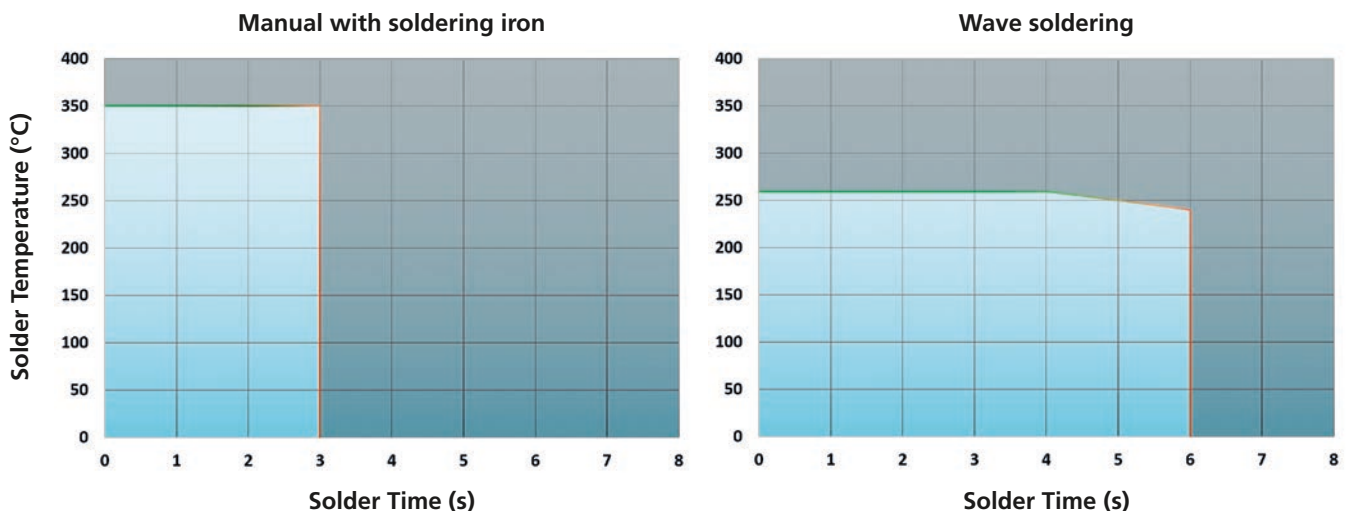

> Glossary · Begriffsverzeichnis

Rated capacitance C_N

Capacitance value rated at 20°C / rated frequency.

Rated Voltage U_N

The maximum or peak voltage of either polarity of a reversing or non-reversing type wave form for which the capacitor has been designed and rated (unlike other standards for AC capacitors, the rated voltage is not the rms value).

Non repetitive peak (surge) voltage U_s

Voltages beyond the rated voltage induced by switching or faults of the system or any part of it. Maximum count 1000 times with a duration of not more than 50 ms each.

Ripple voltage U_r

The peak-to-peak alternating component of the unidirectional voltage.

Voltage test between terminals U_{TT}

Routine test of all capacitors conducted at room temperature, prior to delivery. A further test with 80 % of the test voltage stated in the data sheet may be carried out once at the user's location.

Voltage test between terminals and case U_{TC}

Routine test of all capacitors between shortcircuited terminals and case, conducted at room temperature. May be repeated at the user's location.

Rated current I_r

rms value of permissible ripple current in continuous operation and frequencies between 1 kHz and 10 kHz when U_N is applied at the rated temperature.

Maximum current I_{max}

Maximum rms value of permissible current in continuous operation. The values given in the data sheets are related to either the specified maximum power dissipation or to the terminals current limits.

Peak current \hat{I}

Maximum permitted repetitive current amplitude during continuous operation.

Non-repetitive peak current (surge) I_s

Maximum current that may occur non-repetitively and briefly in the event of a fault. Maximum count 1000 times with a duration of not more than 50 ms each.

Nennkapazität C_N

Nennkapazitätswert bei 20°C / Nennfrequenz.

Nennspannung U_N

Die Höchst- oder Spitzenspannung jeder Polarität einer umkehrbaren oder nicht umkehrbaren Wellenform, für die der Kondensator ausgelegt und bemessen wurde (im Gegensatz zu anderen Normen für Wechselstrom-kondensatoren ist die Nennspannung nicht die rms Spannung).

Nicht repetitive Überspannungsspitze U_s

durch Schaltvorgänge oder Fehler des Systems verursachte Spannungen oberhalb der Nennspannung. Maximal 1000-mal mit einer Dauer von jeweils bis zu 50 ms.

Ripple Spannung U_r

Die Spitze-zu-Spitze-Wechselkomponente der uni-direktionalen Spannung.

Spannungsprüfung zwischen den Anschlüssen U_{TT}

Routineprüfung aller Kondensatoren bei Raumtemperatur vor der Auslieferung. Eine weitere Prüfung mit 80 % der im Datenblatt angegebenen Prüfspannung kann einmalig beim Anwender durchgeführt werden.

Spannungstest zwischen Anschlüssen und Gehäuse U_{TC}

Routineprüfung bei Raumtemperatur aller Kondensatoren zwischen kurzgeschlossenen Anschlüssen und Gehäuse, Kann beim Anwender vor Ort wiederholt werden.

Nennstrom I_r

RMS Effektivwert des zulässigen Ripple Stroms im Dauerbetrieb und für den Frequenzbereich 1 kHz bis 10 kHz wenn die Nennspannung ansteht und bei Nenntemperatur.

Maximaler Strom I_{max}

Maximaler RMS Effektivwert des zulässigen Stroms im Dauerbetrieb. Die in den Datenblättern angegebenen Werte beziehen sich entweder auf die angegebene maximale Verlustleistung oder auf das Limit der Anschlussklemmen.

Spitzenstrom \hat{I}

Maximal zulässige wiederholbare Stromamplitude im Dauerbetrieb.

Nicht repetitiver Spitzenstrom (Surge) I_s

Maximaler Strom, der im Fehlerfall nicht wiederkehrend und kurzzeitig auftreten darf. Maximal 1000-mal mit einer Dauer von jeweils bis zu 50 ms.

Dielectric dissipation factor $\tan\delta_0$

Constant dissipation factor of the dielectric material for all capacitors in their rated frequency.

Thermal resistance R_{th}

The thermal resistance indicates by how many degrees the capacitor temperature at the hotspot rises in relation to the dissipation losses.

Maximum power dissipation P_{max}

Maximum permitted power dissipation for the capacitor's operation at a certain ambient temperature.

Ambient temperature T_a

Temperature of the surrounding air, measured 10 cm away and at 2/3 of the case height of the capacitor.

Lower category temperature T_{min}

Lowest permissible ambient temperature at which a capacitor may be used.

Upper category temperature T_{max}

Highest permissible capacitor temperature during operation, i.e. temperature at the hottest point of the case.

Hotspot temperature $T_{HOTSPOT}$

Temperature at the hottest spot inside the capacitor.

Rated energy contents E_N

Energy stored in the capacitor when charged at rated voltage.

Clearance in air L

The shortest distance between conducting parts of the terminals or between terminals and case.

Creepage distance K

The shortest distance along an insulated surface between conducting parts of the terminals or between terminals and case

Resonant frequency f_{res}

The capacitance and self-inductance of any capacitor form a series resonant circuit. Above the resonant frequency, the inductive part of this LC-circuit prevails. The capacitor would then behave as an inductor.

Dielektrischer Verlustfaktor $\tan\delta_0$

Konstanter Verlustfaktor des dielektrischen Materials für alle Kondensatoren bei ihrer Nennfrequenz.

Thermischer Widerstand R_{th}

Der Wärmewiderstand gibt an, um wie viel Grad die Temperatur des Kondensators im Hotspot im Verhältnis zu den Verlusten ansteigt.

Maximale Verlustleistung P_{max}

Maximal zulässige Verlustleistung für den Betrieb des Kondensators bei einer bestimmten Umgebungstemperatur.

Umgebungstemperatur T_a

Temperatur der Umgebungsluft, gemessen in 10 cm Entfernung und auf 2/3 der Gehäusehöhe des Kondensators.

Untere Betriebstemperatur T_{min}

Niedrigste zulässige Umgebungstemperatur für den Betrieb des Kondensators.

Obere Betriebstemperatur T_{max}

Höchste zulässige Kondensatortemperatur während des Betriebs, d. h. Temperatur an der heißesten Stelle des Gehäuses.

Hotspot-Temperatur $T_{HOTSPOT}$

Temperatur an der heißesten Stelle im Inneren des Kondensators.

Nenn-Energiewert E_N

Im Kondensator gespeicherte Energie bei Aufladung mit Nennspannung.

Sicherheitsabstand L

Der kürzeste Abstand zwischen den leitenden Teilen der Anschlüsse oder zwischen Anschlüssen und Gehäuse.

Kriechstrecke K

Der kürzeste Abstand entlang einer isolierten Fläche zwischen leitenden Teilen der Anschlüsse oder zwischen Anschlüssen und Gehäuse

Resonanzfrequenz f_{res}

Die Kapazität und die Selbstinduktivität eines jeden Kondensators bilden einen Reihenschwingkreis. Oberhalb der Resonanzfrequenz überwiegt der induktive Teil dieses LC-Kreises. Der Kondensator würde sich dann wie eine Induktivität verhalten.

Compliance statement

Compliance Erklärung

As a well-established European supplier of electronic components, we are aware of our responsibilities and obligations in regards to the laws and regulations concerning the safety, health and welfare at work of every single person working along our supply chain as well as of the people who come into contact with our components.

This leads AIC Europe to exclusively work with manufacturers who share our respect for human rights, ethics and the protection of the environment and in particular to take due diligence, that their parts entirely complies with the applicable regulations.

Products and accessories from this catalog comply among other with the following regulations and directives at the beginning of 2026:

Als langjähriger europäischer Lieferant von elektronischen Bauteilen sind wir uns unserer Verantwortung und Verpflichtung gegenüber den Gesetzen und Vorschriften in Bezug auf die Sicherheit, die Gesundheit und das Wohlergehen jedes einzelnen Mitarbeiters in unserer Lieferkette sowie der Menschen, die mit unseren Bauteilen in Berührung kommen, bewusst.

Dies veranlasst AIC Europe, ausschließlich mit Herstellern zusammenzuarbeiten, die unsere Achtung der Menschenrechte, der Ethik und des Umweltschutzes teilen und insbesondere darauf zu achten, dass ihre Erzeugnisse den geltenden Vorschriften vollständig entsprechen.

Produkte und Zubehör aus diesem Katalog erfüllen zu Beginn 2026 unter anderen folgende Vorschriften:

- Restriction of Hazardous Substances Directive **RoHS** 2011/65/EU & amendment (EU)2015/863
- Regulation (EC) No 1907/2006 **REACH**
Registration, Evaluation, Authorisation and Restriction of Chemicals based on the SVHC candidate list updated by 2026, February 4th
- OECD Due Diligence Guidance for Responsible Supply Chains of Minerals from Conflict-Affected and High-Risk Areas by providing for all our products
 - a Conflict Minerals Reporting Template (**CMRT**) in accordance with the Dodd-Frank Wall Street Reform and Consumer Protection Act, Section 1502 on conflict minerals
 - an Extended Minerals Reporting Template (**EMRT**) for further conflict minerals
- Regulation/Verordnung (EU) 2019/1021 on persistent organic pollutants – **POP** amended by delegated Regulation (EU) 2021/277
- Safe Drinking Water and Toxic Enforcement Act of 1986 (California's Proposition **CP65**)
Chemicals known to the State to cause cancer or reproductive toxicity (as of Dec 8, 2020)
- Toxic Substances Control Act 1976 EPA **TSCA** 6 (h)



AICtech & AIC EUROPE

AIC tech and AIC EUROPE remain committed to

- continuously collect relevant information with our reasonably best available effort from our suppliers and provide our best available information to our customers
- provide updated information timely to the customers when we receive modified or added information from our suppliers
- strive to spread this approach along our supply chains to ensure that, in the end, our customers too comply with the relevant regulations

AIC tech und AIC EUROPE verpflichten sich weiterhin

- kontinuierlich und nach bestem Wissen und Gewissen relevante Informationen von ihren Lieferanten zu sammeln und ihren Kunden die besten verfügbaren Informationen zur Verfügung zu stellen.
- ihren Kunden rechtzeitig aktualisierte Informationen zur Verfügung zu stellen, wenn wir geänderte oder zusätzliche Informationen von unseren Lieferanten erhalten
- sich zu bemühen, diesen Ansatz entlang unserer Lieferketten zu verbreiten, um sicherzustellen, dass am Ende auch unsere Kunden die relevanten Vorschriften einhalten.

Screw Type Series Data

MLC · MLC2 · MLCA



MLC · Screw-Terminal · 85 °C

Standard Performances · Fuse Function · high withstanding Voltage

Optional UL 810 standard compliance with series MLCU

Optionale Einhaltung der Norm UL 810 mit der Serie MLCU

> Specifications · Spezifikationen

Items	Characteristics
Temperature range	-40 °C ~ +85 °C at 0.7 U _N
	-40 °C ~ +80 °C at 0.8 U _N
	-40 °C ~ +75 °C at 0.9 U _N
	-40 °C ~ +70 °C at 1.0 U _N
Rated Voltage U _N	900 ~ 1500Vdc (other available on request)
Voltage test between terminals U _{TT}	1.5 x U _N / 10 s
Voltage test terminals to case U _{TC}	3200Vac / 10 s
Terminals	M6 x 10 (refer to p. 8)
Stud Bolt	M12 x 16 (refer to p. 8)
Life Time Test / Reference Standard	IEC 61071 : 2007
Life Time Expectancy	150 000 hrs (T _{HOTSPOT} 70 °C, 1.0 x U _N)
Failure Rate	<= 0.5 FIT = 0.5 x 10 ⁻⁹ Failures / hour
Dielectric	Polypropylene
Safety Function	Segmented metallized film with Fuse Function
Cap / Impregnants	UL94V-0 listed PBT / Epoxy / Urethane Resin
Case material	Aluminum
Humidity	Class F : 75 % annual average, 95 % 30days / year
Product Compliance	RoHS, REACH, Conflict Minerals a.o. - refer to p.12 – 13



> Dimensions · Abmessungen

For details refer to p. 8 · Technische Details siehe S. 8

Dimensions (mm)	ØD				
	Ø 85	Ø 88.5	Ø 100	Ø 116	Ø 140
Terminal Pitch P	32	32	32	50	50
Diameter at Terminal Ø dT	12	12	12	14	19
Terminal Length T _L	5	5	5	5	5
Cap Length L _c	15	15	15	20	20
Optional Stud Bolt Length L _s	16	16	16	18	18
Clearance distance (mm)	20	20	20	36	31
Creepage distance (mm)	28	28	28	36	31
Permissible terminal current (Arms)	60	60	60	80	100

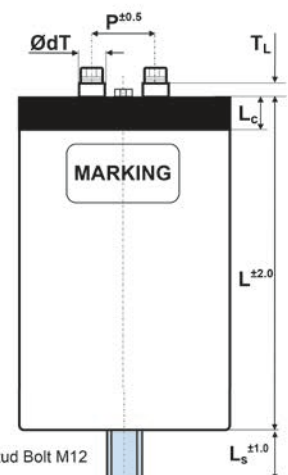
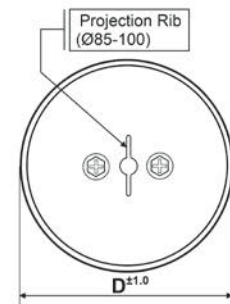

> Ripple Current Multiplier · I_r Strom Multiplikatoren

I _r Multiplier (1 kHz – 10 kHz)				
Ambient Temp.	0.7x U _N	0.8x U _N	0.9x U _N	1.0x U _N
T _a = 50°C	1.32	1.22	1.11	1.00
T _a = 60°C	1.11	1.00	0.86	0.70
T _a = 70°C	0.86	0.70	0.50	0.00
T _a = 75°C	0.70	0.50	0.00	
T _a = 80°C	0.50	0.00		
T _a = 85°C	0.00			

I_{max} is to be controlled below the permissible terminal current. Please contact us if ripple current includes frequencies below 1 kHz and/or above 10 kHz.

Optional Stud Bolt M12

> Product Code · Bestellbezeichnung

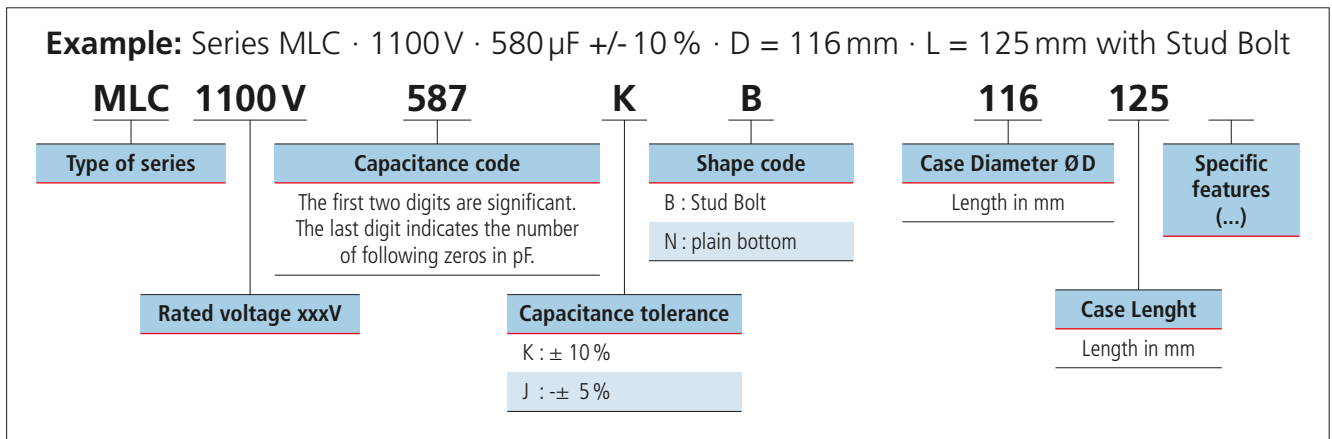

Rated DC Voltage U_N Max ripple Voltage U_r Non repetitive Surge Volt. U_s	Nominal Capacitance C_N [µF]	Ripple Current at 50°C 1 k–10 kHz I_r^* [A RMS]	Peak Current Maximum value \hat{I} [kA]	Surge Current Maximum value I_s [kA]	ESR ESR [mΩ]	ESL ESL [nH]	Thermal Resistance R_{th} [K/W]	Case Size D x L [mm]	Product Code # = variable value, see fixing code in the product code
900 VDC Ripple Voltage 200 V Surge Voltage 1350 V	180	28	4	12	2.9	60	8.4	85x70	MLC900V187K#8570
	200	28	4	12	3.1	65	7.9	85x75	MLC900V207K#8575
	210	31	5	15	2.6	60	7.8	88.5x70	MLC900V217K#88570
	230	28	4	12	3.3	65	7.4	85x80	MLC900V237K#8580
		30	5	15	2.8	65	7.7	88.5x75	MLC900V237K#88575
	250	30	4	12	3.1	65	7.0	88.5x80	MLC900V257K#88580
	260	28	4	12	3.7	75	6.8	85x87	MLC900V267K#8587
	270	37	6	18	2.2	60	6.5	100x70	MLC900V277K#10070
	280	28	4	12	3.4	75	6.8	88.5x87	MLC900V287K#88587
	290	27	4	12	4.1	80	6.4	85x95	MLC900V297K#8595
	300	37	6	18	2.3	65	6.1	100x75	MLC900V307K#10075
	320	29	4	12	3.8	80	6.1	88.5x95	MLC900V327K#88595
	330	27	4	12	4.8	90	5.6	85x106	MLC900V337K#85106
		36	6	18	2.5	65	5.9	100x80	MLC900V337K#10080
	360	28	4	12	4.4	90	5.7	88.5x106	MLC900V367K#885106
	370	52	8	24	1.5	40	4.8	85x125	MLC900V377K#85125
		36	6	18	2.8	75	5.4	100x87	MLC900V377K#10087
	380	43	8	24	1.7	60	6.0	116x70	MLC900V387K#11670
	390	26	4	12	5.5	100	5.2	85x120	MLC900V397K#85120
	410	52	8	24	1.6	40	4.5	85x135	MLC900V417K#85135
		43	8	24	1.9	65	5.6	116x75	MLC900V417K#11675
	420	56	9	27	1.4	40	4.5	88.5x125	MLC900V427K#885125
		34	6	18	3.1	80	5.4	100x95	MLC900V427K#10095
	430	28	5	15	5.1	100	4.9	88.5x120	MLC900V437K#885120
	460	52	8	24	1.7	45	4.1	85x145	MLC900V467K#85145
		56	9	27	1.5	40	4.2	88.5x135	MLC900V467K#885135
		43	8	24	2.0	65	5.2	116x80	MLC900V467K#11680
	480	34	6	18	3.5	90	4.7	100x106	MLC900V487K#100106
510	55	9	27	1.6	45	4.0	88.5x145	MLC900V517K#885145	
	52	8	24	1.9	50	3.8	85x159	MLC900V527K#85159	
520	42	8	24	2.2	75	5.0	116x87	MLC900V527K#11687	

* additional information for I_r on page 16

Additional designs on request · Weitere Designs auf Anfrage

Rated DC Voltage U_N Max ripple Voltage U_r Non repetitive Surge Volt. U_s	Nominal Capacitance C_N [µF]	Ripple Current at 50°C 1 k–10 kHz I_r^* [A RMS]	Peak Current Maximum value \hat{I} [kA]	Surge Current Maximum value I_s [kA]	ESR		Thermal Resistance		Case Size D x L [mm]	Product Code # = variable value, see fixing code in the product code
					ESR [mΩ]	ESL [nH]	R_{th} [K/W]			
900 VDC Ripple Voltage 200 V Surge Voltage 1350 V	540	60	12	36	1.1	40	3.9	100x125	MLC900V547K#100125	
	560	33	6	18	4.1	100	4.3	100x120	MLC900V567K#100120	
	570	55	9	27	1.8	50	3.6	88.5x159	MLC900V577K#885159	
		46	12	36	1.4	60	6.6	140x70	MLC900V577K#14070	
	590	52	8	24	2.1	55	3.4	85x175	MLC900V597K#85175	
		42	8	24	2.4	80	4.5	116x95	MLC900V597K#11695	
	600	60	12	36	1.2	40	3.6	100x135	MLC900V607K#100135	
	630	46	12	36	1.4	65	6.6	140x75	MLC900V637K#14075	
	650	55	9	27	2.0	55	3.2	88.5x175	MLC900V657K#885175	
	660	51	8	24	2.5	60	3.0	85x197	MLC900V667K#85197	
		41	8	24	2.8	90	4.2	116x106	MLC900V667K#116106	
	670	60	12	36	1.3	45	3.5	100x145	MLC900V677K#100145	
	700	46	12	36	1.6	65	5.8	140x80	MLC900V707K#14080	
	730	54	9	27	2.3	60	2.9	88.5x197	MLC900V737K#885197	
	750	60	12	36	1.5	50	3.2	100x159	MLC900V757K#1001509	
	760	77	16	48	0.9	40	3.5	116x125	MLC900V767K#116125	
	780	41	8	24	3.2	100	3.6	116x120	MLC900V787K#116120	
		50	8	24	2.9	70	2.7	85x225	MLC900V787K#85225	
		46	12	36	1.7	75	5.4	140x87	MLC900V787K#14087	
	830	77	16	48	1.0	40	3.3	116x135	MLC900V837K#116135	
	850	60	12	36	1.6	55	2.8	100x175	MLC900V857K#100175	
	870	54	9	27	2.6	70	2.6	88.5x225	MLC900V877K#885225	
	880	76	15	45	1.1	45	3.0	116x145	MLC900V887K#116145	
	890	45	12	36	1.9	80	5.1	140x95	MLC900V897K#14095	
	930	77	16	48	1.1	45	3.1	116x145	MLC900V937K#116145	
	960	60	12	36	1.9	60	2.5	100x197	MLC900V967K#100197	
	1000	76	16	48	1.2	50	2.8	116x159	MLC900V108K#116159	
		44	12	36	2.1	90	4.8	140x106	MLC900V108K#140106	
1100	60	11	33	2.2	70	2.2	100x225	MLC900V118K#100225		
	75	15	45	1.4	55	2.5	116x175	MLC900V118K#116175		
	43	11	33	2.5	100	4.2	140x120	MLC900V118K#140120		
	80	24	72	0.8	40	3.8	140x125	MLC900V118K#140125		
1200	80	23	69	0.8	40	3.8	140x135	MLC900V128K#140135		
1300	75	16	48	1.5	60	2.3	116x197	MLC900V138K#116197		
1400	81	24	72	0.8	45	3.7	140x145	MLC900V148K#140145		
1500	74	16	48	1.8	70	2.0	116x225	MLC900V158K#116225		
	80	23	69	0.9	50	3.4	140x159	MLC900V158K#140159		
1700	79	23	69	1.0	55	3.2	140x175	MLC900V178K#140175		
2000	80	24	72	1.2	60	2.6	140x197	MLC900V208K#140197		
2300	79	24	72	1.3	70	2.3	140x225	MLC900V238K#140225		
1100 VDC Ripple Voltage 250 V Surge Voltage 1650 V	140	26	3	9	3.3	60	8.6	85x70	MLC1100V147K#8570	
	160	27	4	12	3.5	65	7.6	85x75	MLC1100V167K#8575	
	170	29	4	12	2.8	60	8.3	88.5x70	MLC1100V177K#88570	
	180	27	4	12	3.7	65	7.1	85x80	MLC1100V187K#8580	
		29	4	12	3.1	65	7.5	88.5x75	MLC1100V187K#88575	

* additional information for I_r on page 16

Additional designs on request · Weitere Designs auf Anfrage

Rated DC Voltage U_N Max ripple Voltage U_r Non repetitive Surge Volt. U_s	Nominal Capacitance C_N [μF]	Ripple Current at 50°C 1k–10kHz I_r^* [A RMS]	Peak Current Maximum value \hat{I} [kA]	Surge Current Maximum value I_s [kA]	ESR		ESL		Thermal Resistance R_{th} [K/W]	Case Size $D \times L$ [mm]	Product Code # = variable value, see fixing code in the product code
					ESR [mΩ]	ESL [nH]					
1100 VDC Ripple Voltage 250 V Surge Voltage 1650 V	200	26	4	12	4.2	75	6.9	85x87	MLC1100V207K#8587		
		28	4	12	3.4	65	7.3	88.5x80	MLC1100V207K#88580		
	210	34	5	15	2.4	60	6.9	100x70	MLC1100V217K#10070		
		230	26	4	12	4.6	80	6.2	85x95	MLC1100V237K#8595	
	28		4	12	3.7	75	6.7	88.5x87	MLC1100V237K#88587		
	34		5	15	2.6	65	6.4	100x75	MLC1100V237K#10075		
	260	25	4	12	5.3	90	5.8	85x106	MLC1100V267K#85106		
		28	4	12	4.1	80	6.1	88.5x95	MLC1100V267K#88595		
		33	5	15	2.8	65	6.3	100x80	MLC1100V267K#10080		
	290	50	7	21	1.7	40	4.7	85x125	MLC1100V297K#85125		
		27	4	12	4.8	90	5.6	88.5x106	MLC1100V297K#885106		
		33	5	15	3.1	75	5.8	100x87	MLC1100V297K#10087		
		41	7	21	1.9	60	6.0	116x70	MLC1100V297K#11670		
	310	25	4	12	6.1	100	5.1	85x120	MLC1100V317K#85120		
	320	50	7	21	1.8	40	4.3	85x135	MLC1100V327K#85135		
		41	7	21	2.1	65	5.6	116x75	MLC1100V327K#11675		
	330	53	8	24	1.5	40	4.6	88.5x125	MLC1100V337K#885125		
		33	5	15	3.4	80	5.2	100x95	MLC1100V337K#10095		
	350	27	4	12	5.5	100	4.9	88.5x120	MLC1100V357K#885120		
	360	49	7	21	1.9	45	4.2	85x145	MLC1100V367K#85145		
		41	7	21	2.2	65	5.2	116x80	MLC1100V367K#11680		
	370	54	8	24	1.6	40	4.2	88.5x135	MLC1100V377K#885135		
	380	32	5	15	3.9	90	4.8	100x106	MLC1100V387K#100106		
	390	50	8	24	1.8	45	4.3	85x137.5	MLC1100V397K#851375		
	400	50	8	24	1.8	45	4.4	85x135	MLC1100V407K#851375		
		49	7	21	2.2	50	3.7	85x159	MLC1100V407K#85159		
		40	7	21	2.4	75	5.0	116x87	MLC1100V407K#11687		
	410	53	8	24	1.7	45	4.1	88.5x145	MLC1100V417K#885145		
	440	60	10	30	1.2	40	3.9	100x125	MLC1100V447K#100125		
	450	60	8	24	1.5	50	3.7	88.5x159	MLC1100V457K#885159		
		32	5	15	4.5	100	4.2	100x120	MLC1100V457K#100120		
	460	49	7	21	2.4	55	3.4	85x175	MLC1100V467K#85175		
		53	8	24	1.9	50	3.7	88.5x159	MLC1100V467K#885159		
		40	7	21	2.7	80	4.5	116x95	MLC1100V467K#11695		
		45	11	33	1.4	60	6.9	140x70	MLC1100V467K#14070		
	470	60	10	30	1.4	40	3.6	100x135	MLC1100V477K#100135		
	500	49	8	24	2.2	55	3.6	88.5x175	MLC1100V507K#885175		
		45	11	33	1.6	65	6.0	140x75	MLC1100V507K#14075		
	520	60	10	30	1.5	45	3.4	100x145	MLC1100V527K#100145		
	530	48	7	21	2.7	60	3.1	85x197	MLC1100V537K#85197		
53		8	24	2.1	55	3.3	88.5x175	MLC1100V537K#885175			
40		7	21	3.0	90	4.0	116x106	MLC1100V537K#116106			
560	44	11	33	1.7	65	5.9	140x80	MLC1100V567K#14080			

* additional information for I_r on page 16

Additional designs on request · Weitere Designs auf Anfrage

Rated DC Voltage U_N Max ripple Voltage U_r Non repetitive Surge Volt. U_s	Nominal Capacitance C_N [μ F]	Ripple Current at 50°C 1 k–10 kHz I_r^* [A RMS]	Peak Current Maximum value \hat{I} [kA]	Surge Current Maximum value I_s [kA]	ESR		ESL		Thermal Resistance R_{th} [K/W]	Case Size $D \times L$ [mm]	Product Code # = variable value, see fixing code in the product code
					ESR [m Ω]	ESL [nH]					
1100 VDC Ripple Voltage 250 V Surge Voltage 1 650 V	580	80	7	20	1.2	50	3.2	100x155	MLCU1100V587K#100155R		
		60	10	30	1.6	50	3.1	100x159	MLC1100V587K#100159		
		73	14	42	1.0	40	3.6	116x125	MLC1100V587K#116125		
	590	52	8	24	2.5	60	2.9	88.5x197	MLC1100V597K#885197		
		48	7	21	3.2	70	2.7	85x225	MLC1100V627K#85225		
	620	39	7	21	3.5	100	3.6	116x120	MLC1100V627K#116120		
		44	11	33	1.8	75	5.6	140x87	MLC1100V637K#14087		
	650	74	14	42	1.1	40	3.3	116x135	MLC1100V657K#116135		
	690	60	10	30	1.7	55	2.9	100x175	MLC1100V697K#100175		
	700	51	8	24	2.9	70	2.6	88.5x225	MLC1100V707K#885225		
	720	74	14	42	1.2	45	3.0	116x145	MLC1100V727K#116145		
		44	11	33	2.0	80	5.0	140x95	MLC1100V727K#14095		
	750	48	7	21	3.4	75	2.4	85x252	MLC1100V757K#85252		
		75	15	45	1.1	45	3.1	116x145	MLC1100V757K#116145		
	760	60	10	30	2.0	60	2.5	100x197	MLC1100V767K#100197		
	810	73	14	42	1.3	50	2.8	116x159	MLC1100V817K#116159		
		43	11	33	2.3	90	4.6	140x106	MLC1100V817K#140106		
	900	60	10	30	2.4	70	2.2	100x225	MLC1100V907K#100225		
		73	14	42	1.4	55	2.6	116x175	MLC1100V927K#116175		
	920	79	22	66	0.8	40	3.9	140x125	MLC1100V927K#140125		
		43	11	33	2.6	100	4.1	140x120	MLC1100V957K#140120		
	1000	71	14	42	1.7	60	2.3	116x197	MLC1100V108K#116197		
		79	22	66	0.8	40	3.9	140x135	MLC1100V108K#140135		
		62	13	39	2.0	70	2.5	116x225	MLC1100V118K#116225		
	1100	78	22	66	0.9	45	3.6	140x145	MLC1100V118K#140145		
		77	21	63	1.0	50	3.3	140x159	MLC1100V128K#140159		
	1200	71	14	42	1.9	70	2.0	116x225	MLC1100V128K#116225		
		80	15	45	1.5	70	2.0	116x235	MLCU1100V148K#116235S		
	1400	78	21	63	1.1	55	2.9	140x175	MLC1100V148K#140175		
		77	22	66	1.2	60	2.8	140x197	MLC1100V168K#140197		
1900	77	22	66	1.4	70	2.4	140x225	MLC1100V198K#140225			
1300 VDC Ripple Voltage 300 V Surge Voltage 1 950 V	100	25	3	9	3.8	60	8.1	85x70	MLC1300V107K#8570		
	110	25	3	9	4.1	65	7.6	85x75	MLC1300V117K#8575		
		26	3	9	3.5	60	8.2	88.5x70	MLC1300V117K#88570		
	120	26	3	9	3.8	65	7.6	88.5x75	MLC1300V127K#88575		
	130	25	3	9	4.2	65	7.3	85x80	MLC1300V137K#8580		
	140	24	3	9	4.8	75	7.0	85x87	MLC1300V147K#8587		
		26	3	9	4.0	65	7.2	88.5x80	MLC1300V147K#88580		
	150	32	4	12	2.7	60	6.9	100x70	MLC1300V157K#10070		
		24	3	9	5.4	80	6.3	85x95	MLC1300V167K#8595		
	160	26	3	9	4.3	75	6.7	88.5x87	MLC1300V167K#88587		
		32	4	12	2.9	65	6.5	100x75	MLC1300V177K#10075		
	180	26	3	9	4.8	80	6.0	88.5x95	MLC1300V187K#88595		
		31	4	12	3.3	65	6.2	100x80	MLC1300V187K#10080		

* additional information for I_r on page 16

Additional designs on request · Weitere Designs auf Anfrage

Rated DC Voltage U_N Max ripple Voltage U_r Non repetitive Surge Volt. U_s	Nominal Capacitance C_N [μF]	Ripple Current at 50°C 1 k–10 kHz I_r^* [A RMS]	Peak Current Maximum value \hat{I} [kA]	Surge Current Maximum value I_s [kA]	ESR		ESL		Thermal Resistance R_{th} [K/W]	Case Size $D \times L$ [mm]	Product Code # = variable value, see fixing code in the product code
					ESR [mΩ]	ESL [nH]					
1300 VDC Ripple Voltage 300 V Surge Voltage 1950 V	190	24	3	9	6.0	90	5.6	85x106	MLC1300V197K#85106		
	200	25	3	9	5.7	90	5.5	88.5x106	MLC1300V207K#885106		
	210	47	6	18	1.9	40	4.7	85x125	MLC1300V217K#85125		
		31	4	12	3.5	75	5.8	100x87	MLC1300V217K#10087		
	220	39	6	18	2.1	60	5.9	116x70	MLC1300V217K#11670		
		23	3	9	7.0	100	5.2	85x120	MLC1300V227K#85120		
	230	47	6	18	2.0	40	4.3	85x135	MLC1300V237K#85135		
		50	7	21	1.7	40	4.6	88.5x125	MLC1300V237K#885125		
		39	6	18	2.3	65	5.5	116x75	MLC1300V237K#11675		
	240	25	3	9	6.5	100	4.8	88.5x120	MLC1300V247K#885120		
		31	4	12	3.8	80	5.2	100x95	MLC1300V247K#10095		
	250	49	7	21	1.9	40	4.3	88.5x135	MLC1300V257K#885135		
	260	47	6	18	2.2	45	4.0	85x145	MLC1300V267K#85145		
		39	6	18	2.5	65	5.2	116x80	MLC1300V267K#11680		
	270	30	4	12	4.4	90	4.8	100x106	MLC1300V277K#100106		
	280	49	7	21	2.0	45	4.1	88.5x145	MLC1300V287K#885145		
	290	46	6	18	2.4	50	3.8	85x159	MLC1300V297K#85159		
		38	6	18	2.7	75	4.9	116x87	MLC1300V297K#11687		
	300	47	6	18	2.4	50	3.7	88.5x155	MLC1300V307K#885155		
		59	9	27	1.4	40	3.9	100x125	MLC1300V307K#100125		
	310	42	9	27	1.7	60	6.5	140x70	MLC1300V317K#14070		
	320	49	7	21	2.2	50	3.7	88.5x159	MLC1300V327K#885159		
		30	4	12	5.1	100	4.2	100x120	MLC1300V327K#100120		
	330	46	6	18	2.7	55	3.4	85x175	MLC1300V337K#85175		
		59	9	27	1.5	40	3.6	100x135	MLC1300V337K#100135		
		38	6	18	3.0	80	4.5	116x95	MLC1300V337K#11695		
	350	43	9	27	1.7	65	6.2	140x75	MLC1300V357K#14075		
	360	49	7	21	2.5	55	3.3	88.5x175	MLC1300V367K#885175		
	370	59	9	27	1.7	45	3.3	100x145	MLC1300V377K#100145		
	380	46	6	18	3.1	60	3.0	85x197	MLC1300V387K#85197		
		38	6	18	3.4	90	3.9	116x106	MLC1300V387K#116106		
		42	9	27	1.9	65	5.8	140x80	MLC1300V387K#14080		
410	48	7	21	2.9	60	2.9	88.5x197	MLC1300V417K#885197			
420	59	9	27	1.8	50	3.1	100x159	MLC1300V427K#100159			
	70	12	36	1.1	40	3.5	116x125	MLC1300V427K#116125			
430	42	9	27	2.1	75	5.3	140x87	MLC1300V437K#14087			
450	45	6	18	3.5	70	2.7	85x225	MLC1300V457K#85225			
	37	6	18	3.9	100	3.6	116x120	MLC1300V457K#116120			
460	70	12	36	1.2	40	3.3	116x135	MLC1300V467K#116135			
470	57	9	27	2.0	55	2.9	100x175	MLC1300V477K#100175			
480	47	7	21	3.3	70	2.7	88.5x225	MLC1300V487K#885225			
490	69	12	36	1.3	45	3.2	116x140	MLC1300V497K#116140			
	41	9	27	2.3	80	5.1	140x95	MLC1300V497K#14095			
520	70	12	36	1.3	45	3.0	116x145	MLC1300V527K#116145			

* additional information for I_r on page 16

Additional designs on request · Weitere Designs auf Anfrage

Rated DC Voltage U_N Max ripple Voltage U_r Non repetitive Surge Volt. U_s	Nominal Capacitance C_N [µF]	Ripple Current at 50°C 1 k–10 kHz I_r^* [A RMS]	Peak Current Maximum value \hat{I} [kA]	Surge Current Maximum value I_s [kA]	ESR		ESL		Thermal Resistance R_{th} [K/W]	Case Size $D \times L$ [mm]	Product Code # = variable value, see fixing code in the product code
					ESR [mΩ]	ESL [nH]					
1 300 VDC Ripple Voltage 300 V Surge Voltage 1 950 V	550	57	9	27	2.3	60	2.6	100x197	MLC1300V557K#100197		
		40	9	27	2.6	90	4.7	140x106	MLC1300V557K#140106		
	570	54	8	24	2.9	70	2.3	100x225	MLC1300V577K#100225		
	580	70	12	36	1.4	50	2.8	116x159	MLC1300V587K#116159		
	630	75	18	54	0.9	40	3.9	140x125	MLC1300V637K#140125		
	650	57	9	27	2.6	70	2.3	100x225	MLC1300V657K#100225		
		40	9	27	3.0	100	4.1	140x120	MLC1300V657K#140120		
	660	69	12	36	1.6	55	2.6	116x175	MLC1300V667K#116175		
	700	75	18	54	0.9	40	3.9	140x135	MLC1300V707K#140135		
	760	69	12	36	1.8	60	2.3	116x197	MLC1300V767K#116197		
	770	74	18	54	1.0	45	3.6	140x145	MLC1300V777K#140145		
	870	74	18	54	1.1	50	3.3	140x159	MLC1300V877K#140159		
	900	69	13	39	2.1	70	2.0	116x225	MLC1300V907K#116225		
	990	74	18	54	1.2	55	3.0	140x175	MLC1300V997K#140175		
	1 100	73	18	54	1.4	60	2.6	140x197	MLC1300V118K#140197		
1 300	72	18	54	1.6	70	2.4	140x225	MLC1300V138K#140225			
1 500 VDC Ripple Voltage 350 V Surge Voltage 2 250 V	70	23	2	6	4.6	60	8.0	85x70	MLC1500V706K#8570		
		23	2	6	4.8	65	7.7	85x75	MLC1500V806K#8575		
	80	25	3	9	4.0	60	7.8	88.5x70	MLC1500V806K#88570		
		23	3	9	5.1	65	7.1	85x80	MLC1500V906K#8580		
	90	25	3	9	4.3	65	7.2	88.5x75	MLC1500V906K#88575		
		22	2	6	5.7	75	7.0	85x87	MLC1500V107K#8587		
	100	24	3	9	4.7	65	7.2	88.5x80	MLC1500V107K#88580		
		22	2	6	6.5	80	6.1	85x95	MLC1500V117K#8595		
	110	24	3	9	5.2	75	6.5	88.5x87	MLC1500V117K#88587		
		30	4	12	3.1	60	6.9	100x70	MLC1500V117K#10070		
	120	30	4	12	3.4	65	6.3	100x75	MLC1500V127K#10075		
		22	3	9	7.3	90	5.5	85x106	MLC1500V137K#85106		
	130	24	3	9	5.6	80	6.0	88.5x95	MLC1500V137K#88595		
		29	4	12	3.8	65	6.1	100x80	MLC1500V137K#10080		
	150	43	5	15	2.2	50	4.7	85x125	MLC1500V157K#85125		
		24	3	9	6.4	90	5.3	88.5x106	MLC1500V157K#885106		
		29	4	12	4.0	75	5.7	100x87	MLC1500V157K#10087		
		37	5	15	2.5	60	5.7	116x70	MLC1500V157K#11670		
	160	22	3	9	8.1	100	4.9	85x120	MLC1500V167K#85120		
		43	5	15	2.4	50	4.3	85x135	MLC1500V167K#85135		
		36	5	15	2.7	65	5.5	116x75	MLC1500V167K#11675		
	170	23	3	9	7.7	100	4.8	88.5x120	MLC1500V177K#885120		
		47	6	18	2.0	50	4.4	88.5x125	MLC1500V177K#885125		
		29	4	12	4.5	80	5.1	100x95	MLC1500V177K#10095		
	180	43	5	15	2.6	50	4.0	85x145	MLC1500V187K#85145		
		46	6	18	2.2	50	4.2	88.5x135	MLC1500V187K#885135		
		36	5	15	2.9	65	5.1	116x80	MLC1500V187K#11680		
190	28	4	12	5.2	90	4.7	100x106	MLC1500V197K#100106			

* additional information for I_r on page 16

Additional designs on request · Weitere Designs auf Anfrage

Rated DC Voltage U_N Max ripple Voltage U_r Non repetitive Surge Volt. U_s	Nominal Capacitance C_N [μF]	Ripple Current at 50°C 1 k–10 kHz I_r^* [A RMS]	Peak Current Maximum value \hat{I} [kA]	Surge Current Maximum value I_s [kA]	ESR		ESL		Thermal Resistance	Case Size	Product Code # = variable value, see fixing code in the product code
					ESR [mΩ]	ESL [nH]	R_{th} [K/W]	D x L [mm]			
1500 VDC Ripple Voltage 350 V Surge Voltage 2 250 V	200	42	5	15	2.9	50	3.8	85x159	MLC1500V207K#85159		
		45	6	18	2.4	50	4.0	88.5x145	MLC1500V207K#885145		
		34	5	15	3.2	75	5.2	116x87	MLC1500V207K#11687		
	210	54	7	21	1.7	50	3.9	100x125	MLC1500V217K#100125		
		230	42	5	15	3.2	55	3.4	85x175	MLC1500V237K#85175	
	46		6	18	2.6	50	3.6	88.5x159	MLC1500V237K#885159		
	28		4	12	5.9	100	4.2	100x120	MLC1500V237K#100120		
	34		5	15	3.5	80	4.7	116x95	MLC1500V237K#11695		
	40		8	24	1.8	60	6.8	140x70	MLC1500V237K#14070		
	240	54	7	21	1.8	50	3.8	100x135	MLC1500V247K#100135		
	250	40	8	24	2.0	65	6.2	140x75	MLC1500V257K#14075		
	260	45	6	18	2.9	55	3.3	88.5x175	MLC1500V267K#885175		
		53	7	21	2.0	50	3.5	100x145	MLC1500V267K#100145		
	270	42	5	15	3.6	60	3.0	85x197	MLC1500V277K#85197		
		34	5	15	3.9	90	4.3	116x106	MLC1500V277K#116106		
	280	40	8	24	2.1	65	5.8	140x80	MLC1500V287K#14080		
	300	45	6	18	3.3	60	2.9	88.5x197	MLC1500V307K#885197		
		54	7	21	2.1	50	3.2	100x159	MLC1500V307K#100159		
		66	10	30	1.3	50	3.4	116x125	MLC1500V307K#116125		
	320	42	5	15	4.2	70	2.6	85x225	MLC1500V327K#85225		
		34	5	15	4.5	100	3.7	116x120	MLC1500V327K#116120		
		40	8	24	2.3	75	5.3	140x87	MLC1500V327K#14087		
	330	42	5	15	4.2	70	2.6	85x225	MLCU1500V337K#85225		
		66	10	30	1.4	50	3.2	116x135	MLC1500V337K#116135		
	340	53	7	21	2.3	55	3.0	100x175	MLC1500V347K#100175		
	350	44	6	18	3.8	70	2.7	88.5x225	MLC1500V357K#885225		
	360	39	8	24	2.5	80	5.1	140x95	MLC1500V367K#14095		
	370	65	10	30	1.5	50	3.1	116x145	MLC1500V377K#116145		
	390	53	8	24	2.7	60	2.6	100x197	MLC1500V397K#100197		
	400	38	8	24	2.9	90	4.7	140x106	MLC1500V407K#140106		
	410	65	10	30	1.7	50	2.8	116x159	MLC1500V417K#116159		
	460	52	8	24	3.1	70	2.3	100x225	MLC1500V467K#100225		
		71	16	48	1.0	50	3.9	140x125	MLC1500V467K#140125		
	470	65	10	30	1.8	55	2.5	116x175	MLC1500V477K#116175		
	480	38	8	24	3.3	100	4.1	140x120	MLC1500V487K#140120		
	510	71	16	48	1.0	50	3.9	140x135	MLC1500V517K#140135		
	540	64	10	30	2.1	60	2.3	116x197	MLC1500V547K#116197		
	570	71	16	48	1.1	50	2.5	140x145	MLC1500V577K#140145		
	640	64	10	30	2.4	70	2.0	116x225	MLC1500V647K#116225		
		71	16	48	1.2	50	3.2	140x159	MLC1500V647K#140159		
720	70	16	48	1.3	55	3.1	140x175	MLC1500V727K#140175			
810	69	16	48	1.5	60	2.8	140x197	MLC1500V817K#140197			
960	69	16	48	1.8	70	2.3	140x225	MLC1500V967K#140225			

* additional information for I_r on page 16

Additional designs on request · Weitere Designs auf Anfrage

> Life Time Table · Brauchbarkeitsdauer – Tabelle

Lifetime as function of ratio between the effective working voltage U_w and the rated DC voltage U_N													
$T_{HOTSPOT}$	x 0.7	x 0.75	x 0.8	x 0.85	x 0.9	x 0.95	x 1.0	x 1.05	x 1.1	x 1.15	x 1.2	x 1.25	x 1.30
40°C	300	300	300	300	300	300	300	300	300	300	300	204	123
45°C	300	300	300	300	300	300	300	300	300	300	203	120	72
50°C	300	300	300	300	300	300	300	300	300	208	120	70	42
55°C	300	300	300	300	300	300	300	300	217	122	70	41	25
60°C	300	300	300	300	300	300	300	233	128	71	41	24	15
65°C	300	300	300	300	300	300	258	137	75	42	24	14	9
70°C	300	300	300	300	300	295	151	80	44	25	14	8	5
75°C	300	300	300	300	251	124	64	33	19	11	6	3.5	2
80°C	300	300	300	221	105	52	27	14	8	4	2.5	1.5	
85°C	300	199	86	39	19	9	5	2.5	1.5				

khrs value limited to 300 000 hours.

> Life Time Graph · Brauchbarkeitsdauer – Diagramm

Lifetime expectancy depending on hotspot temperature $T_{HOTSPOT}$ versus ratio between the effective working voltage U_w and the rated DC voltage U_N

Lebenserwartung in Abhängigkeit von der hotspot Temperatur $T_{HOTSPOT}$ und dem Verhältnis der tatsächlich anliegenden Spannung zur DC Nennspannung U_N

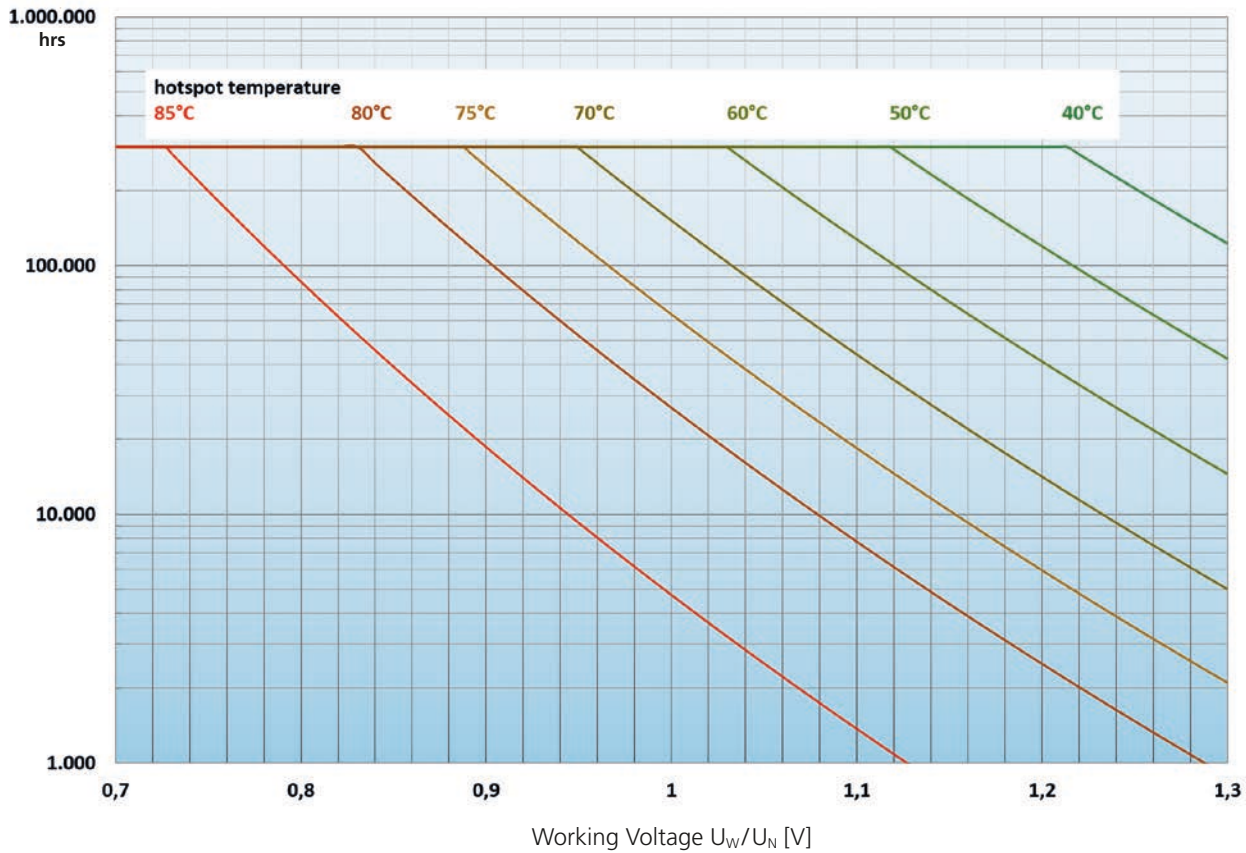

$$T_{HOTSPOT} = T_a + I^2 \times ESR \times R_{th}$$

MLC2 · Screw-Terminal · 85 °C

Large capacitance · Compact · Fuse Function · high withstanding Voltage

Optional UL 810 standard compliance with series MLCU

Optionale Einhaltung der Norm UL 810 mit der Serie MLCU

> Specifications · Spezifikationen

Items	Characteristics
Temperature range	-40 °C ~ +85 °C at 0.7 U _N
	-40 °C ~ +80 °C at 0.8 U _N
	-40 °C ~ +75 °C at 0.9 U _N
	-40 °C ~ +70 °C at 1.0 U _N
Rated Voltage U _N	800 ~ 900Vdc (other available on request)
Voltage test between terminals U _{TT}	1.5 x U _N / 10 s
Voltage test terminals to case U _{TC}	3200Vac / 10 s
Terminals	M6 x 10 (refer to p. 8)
Stud Bolt	M12 x 16 / 18 (refer to p. 8)
Life Time Test / Reference Standard	IEC 61071 : 2007
Life Time Expectancy	150 000 hrs (T _{HOTSPOT} 70 °C, 1.0 x U _N)
Failure Rate	<= 0.5 FIT = 0.5 x 10 ⁻⁹ Failures / hour
Dielectric	Polypropylene
Safety Function	Segmented metallized film with Fuse Function
Cap / Impregnants	UL94V-0 listed PBT / Epoxy / Urethane Resin
Case material	Aluminum
Humidity	Class F : 75 % annual average, 95 % 30days/year
Product Compliance	RoHS, REACH, Conflict Minerals a.o. - refer to p.12 – 13



> Dimensions · Abmessungen

For details refer to p. 8 · Technische Details siehe S. 8

Dimensions (mm)	ØD				
	Ø 85	Ø 88.5	Ø 100	Ø 116	Ø 140
Terminal Pitch P	32	32	32	50	50
Diameter at Terminal Ø dT	12	12	12	14	19
Terminal Length T _L	5	5	5	5	5
Cap Length L _c	15	15	15	20	20
Optional Stud Bolt Length L _s	16	16	16	18	18
Clearance distance (mm)	20	20	20	36	31
Creepage distance (mm)	28	28	28	36	31
Permissible terminal current (Arms)	60	60	60	80	100

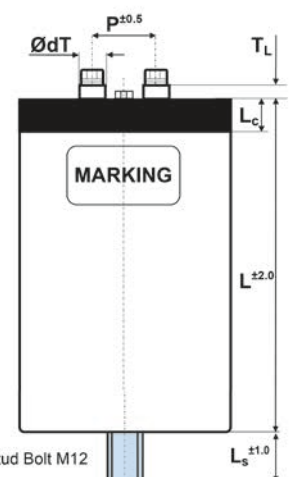
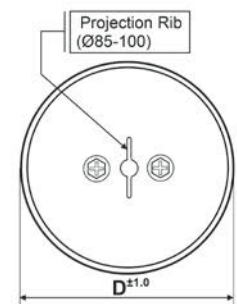

> Ripple Current Multiplier · I_r Strom Multiplikatoren

I _r Multiplier (1 kHz – 10 kHz)				
Ambient Temp.	0.7x U _N	0.8x U _N	0.9x U _N	1.0x U _N
T _a = 50 °C	1.32	1.22	1.11	1.00
T _a = 60 °C	1.11	1.00	0.86	0.70
T _a = 70 °C	0.86	0.70	0.50	0.00
T _a = 75 °C	0.70	0.50	0.00	
T _a = 80 °C	0.50	0.00		
T _a = 85 °C	0.00			

I_{max} is to be controlled below the permissible terminal current. Please contact us if ripple current includes frequencies below 1 kHz and/or above 10 kHz.

Optional Stud Bolt M12

> Product Code · Bestellbezeichnung

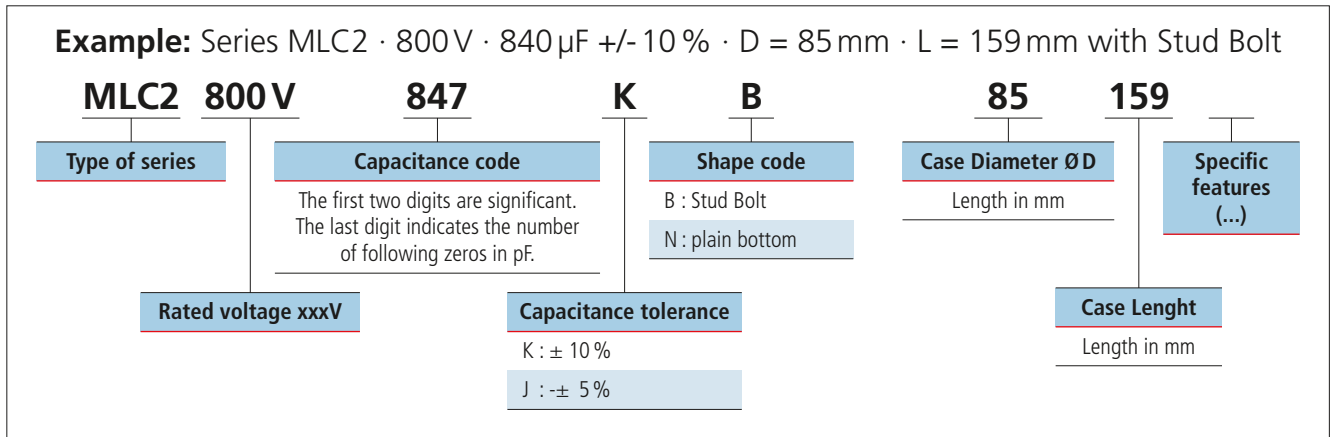

Rated DC Voltage U_N Max ripple Voltage U_r Non repetitive Surge Volt. U_s	Nominal Capacitance C_N [μ F]	Ripple Current at 50°C 1 k–10 kHz I_r^* [A RMS]	Peak Current Maximum value \hat{I} [kA]	Surge Current Maximum value I_S [kA]	ESR ESR [m Ω]	ESL ESL [nH]	Thermal Resistance R_{th} [K/W]	Case Size $D \times L$ [mm]	Product Code # = variable value, see fixing code in the product code
800 VDC Ripple Voltage 200 V Surge Voltage 1200 V	300	31	5	15	2.4	60	8.4	85x70	MLC2800V307K#8570
	330	31	5	15	2.6	65	7.8	85x75	MLC2800V337K#8575
	340	33	6	18	2.2	60	8.1	88.5x70	MLC2800V347K#88570
	370	31	5	15	2.8	65	7.2	85x80	MLC2800V377K#8580
		33	6	18	2.4	65	7.5	88.5x75	MLC2800V377K#88575
	410	33	6	18	2.6	65	6.9	88.5x80	MLC2800V417K#88580
	440	40	7	21	1.8	60	6.8	100x70	MLC2800V447K#10070
	450	31	5	15	3.0	75	6.8	85x87	MLC2800V457K#8587
	470	33	6	18	2.8	75	6.4	88.5x87	MLC2800V477K#88587
	480	30	5	15	3.4	80	6.4	85x95	MLC2800V487K#8595
	490	40	7	21	1.9	65	6.4	100x75	MLC2800V497K#10075
	530	32	6	18	3.1	80	6.1	88.5x95	MLC2800V537K#88595
	540	30	5	15	3.9	90	5.6	85x106	MLC2800V547K#85106
		39	7	21	2.1	65	6.1	100x80	MLC2800V547K#10080
	600	31	6	18	3.6	90	5.6	88.5x106	MLC2800V607K#885106
	610	57	10	30	1.2	40	5.0	85x125	MLC2800V617K#85125
		39	7	21	2.3	75	5.6	100x87	MLC2800V617K#10087
	620	47	10	30	1.5	60	5.9	116x70	MLC2800V627K#11670
	630	29	5	15	4.6	100	5.1	85x120	MLC2800V637K#85120
	670	57	10	30	1.3	40	4.6	85x135	MLC2800V677K#85135
680	62	11	33	1.1	40	4.6	88.5x125	MLC2800V687K#885125	
	47	10	30	1.6	65	5.5	116x75	MLC2800V687K#11675	
690	39	7	21	2.6	80	4.9	100x95	MLC2800V697K#10095	
700	31	6	18	4.2	100	4.9	88.5x120	MLC2800V707K#885120	
750	57	10	30	1.4	45	4.3	85x145	MLC2800V757K#85145	
760	62	11	33	1.2	40	4.2	88.5x135	MLC2800V767K#885135	
	46	10	30	1.7	65	5.4	116x80	MLC2800V767K#11680	
780	38	7	21	3.0	90	4.5	100x106	MLC2800V787K#100106	

* additional information for I_r on page 25

Additional designs on request · Weitere Designs auf Anfrage

Rated DC Voltage U_N Max ripple Voltage U_r Non repetitive Surge Volt. U_s	Nominal Capacitance C_N [μF]	Ripple Current at 50°C 1k–10kHz I_r^* [A RMS]	Peak Current Maximum value \hat{I} [kA]	Surge Current Maximum value I_s [kA]	ESR		Thermal Resistance		Case Size $D \times L$ [mm]	Product Code # = variable value, see fixing code in the product code
					ESR [mΩ]	ESL [nH]	R_{th} [K/W]			
800 VDC Ripple Voltage 200 V Surge Voltage 1200 V	830	61	11	33	1.3	45	4.1	88.5x145	MLC2800V837K#885145	
	840	57	10	30	1.6	50	3.8	85x159	MLC2800V847K#85159	
	850	46	10	30	1.9	75	4.9	116x87	MLC2800V857K#11687	
	890	71	15	45	1.0	40	3.9	100x125	MLC2800V897K#100125	
	920	37	7	21	3.4	100	4.2	100x120	MLC2800V927K#100120	
	930	49	15	45	1.2	60	6.8	140x70	MLC2800V937K#14070	
	940	61	12	36	1.5	50	3.5	88.5x159	MLC2800V947K#885159	
	960	56	10	30	1.8	55	3.5	85x175	MLC2800V967K#85175	
	970	45	10	30	2.1	80	4.6	116x95	MLC2800V977K#11695	
	980	71	15	45	1.0	40	3.9	100x135	MLC2800V987K#100135	
	1000	54	10	30	2.2	60	3.1	85x197	MLC2800V108K#85197	
		59	11	33	1.7	55	3.3	88.5x175	MLC2800V108K#885175	
		69	14	42	1.2	45	3.4	100x145	MLC2800V108K#100145	
		44	10	30	2.5	90	4.0	116x106	MLC2800V108K#116106	
		49	15	45	1.3	65	6.2	140x75	MLC2800V108K#14075	
	1100	49	15	45	1.4	65	5.8	140x80	MLC2800V118K#14080	
	1200	54	10	30	2.5	70	2.7	85x225	MLC2800V128K#85225	
		60	12	36	1.9	60	2.9	88.5x197	MLC2800V128K#885197	
		70	15	45	1.2	50	3.3	100x159	MLC2800V128K#100159	
		43	10	30	2.8	100	3.8	116x120	MLC2800V128K#116120	
		83	20	60	0.8	40	3.6	116x125	MLC2800V128K#116125	
		48	15	45	1.5	75	5.6	140x87	MLC2800V128K#14087	
	1300	69	14	42	1.4	55	3.0	100x175	MLC2800V138K#100175	
		83	20	60	0.9	40	3.2	116x135	MLC2800V138K#116135	
	1400	59	11	33	2.2	70	2.6	88.5x225	MLC2800V148K#885225	
		48	15	45	1.7	80	5.0	140x95	MLC2800V148K#14095	
	1500	68	14	42	1.6	60	2.7	100x197	MLC2800V158K#100197	
		83	20	60	0.9	45	3.2	116x145	MLC2800V158K#116145	
	1600	47	15	45	1.9	90	4.7	140x106	MLC2800V168K#140106	
	1700	83	21	63	1.0	50	2.9	116x159	MLC2800V178K#116159	
	1800	68	15	45	1.8	70	2.4	100x225	MLC2800V188K#100225	
		86	30	90	0.7	40	3.8	140x125	MLC2800V188K#140125	
	1900	83	20	60	1.1	55	2.6	116x175	MLC2800V198K#116175	
		47	15	45	2.1	100	4.2	140x120	MLC2800V198K#140120	
	2000	86	30	90	0.7	40	3.8	140x135	MLC2800V208K#140135	
	2100	80	20	60	1.3	60	2.4	116x197	MLC2800V218K#116197	
	2300	87	31	93	0.8	45	3.2	140x145	MLC2800V238K#140145	
	2500	80	20	60	1.5	70	2.1	116x225	MLC2800V258K#116225	
		86	30	90	0.8	50	3.3	140x159	MLC2800V258K#140159	
	2900	86	31	93	0.9	55	3.0	140x175	MLC2800V298K#140175	
3300	86	31	93	1.0	60	2.7	140x197	MLC2800V338K#140197		
3800	85	30	90	1.2	70	2.3	140x225	MLC2800V388K#140225		

* additional information for I_r on page 25

Additional designs on request · Weitere Designs auf Anfrage

MLC2 · Screw-Terminal · 85 °C

Rated DC Voltage U_N Max ripple Voltage U_r Non repetitive Surge Volt. U_s	Nominal Capacitance C_N [μ F]	Ripple Current at 50°C 1 k–10 kHz I_r^* [A RMS]	Peak Current Maximum value \hat{I} [kA]	Surge Current Maximum value I_s [kA]	ESR		ESL		Thermal Resistance R_{th} [K/W]	Case Size $D \times L$ [mm]	Product Code # = variable value, see fixing code in the product code
					ESR [m Ω]	ESL [nH]					
900 VDC Ripple Voltage 200 V Surge Voltage 1350 V	230	30	4	12	2.6	60	8.3	85x70	MLC2900V237K#8570		
	250	29	4	12	2.9	65	8.0	85x75	MLC2900V257K#8575		
		31	5	15	2.5	60	8.1	88.5x70	MLC2900V257K#88570		
	280	29	4	12	3.1	65	7.5	85x80	MLC2900V287K#8580		
		31	5	15	2.6	65	7.8	88.5x75	MLC2900V287K#88575		
	310	31	5	15	2.9	65	7.0	88.5x80	MLC2900V317K#88580		
	320	29	5	15	3.4	75	6.8	85x87	MLC2900V327K#8587		
	350	31	5	15	3.2	75	6.3	88.5x87	MLC2900V357K#88587		
		39	7	21	2.0	60	6.5	100x70	MLC2900V357K#10070		
	360	28	4	12	3.8	80	6.5	85x95	MLC2900V367K#8595		
	390	38	7	21	2.1	65	6.4	100x75	MLC2900V397K#10075		
	400	30	5	15	3.5	80	6.2	88.5x95	MLC2900V407K#88595		
	410	28	5	15	4.4	90	5.7	85x106	MLC2900V417K#85106		
	430	38	7	21	2.3	65	6.0	100x80	MLC2900V437K#10080		
	450	30	5	15	4.1	90	5.3	88.5x106	MLC2900V457K#885106		
	460	55	9	27	1.4	40	4.6	85x125	MLC2900V467K#85125		
	470	37	7	21	2.6	75	5.6	100x87	MLC2900V477K#10087		
		45	9	27	1.6	60	6.0	116x70	MLC2900V477K#11670		
	480	27	4	12	5.1	100	5.3	85x120	MLC2900V487K#85120		
	510	55	9	27	1.5	40	4.3	85x135	MLC2900V517K#85135		
		59	10	30	1.3	40	4.3	88.5x125	MLC2900V517K#885125		
	530	45	9	27	1.7	65	5.7	116x75	MLC2900V517K#11675		
		29	5	15	4.7	100	4.9	88.5x120	MLC2900V537K#885120		
	540	37	7	21	2.8	80	5.1	100x95	MLC2900V547K#10095		
		54	9	27	1.6	45	4.2	85x145	MLC2900V577K#85145		
	570	59	10	30	1.4	40	4.0	88.5x135	MLC2900V577K#885135		
		44	9	27	1.9	65	5.3	116x80	MLC2900V577K#11680		
	590	36	6	18	3.3	90	4.6	100x106	MLC2900V597K#100106		
	620	56	8	24	1.8	55	3.5	85x175	MLC2900V627K#85175R		
	630	57	10	30	1.5	45	4.0	88.5x145	MLC2900V637K#885145		
	640	54	9	27	1.8	50	3.7	85x159	MLC2900V647K#85159		
	650	44	9	27	2.0	75	5.0	116x87	MLC2900V657K#11687		
	690	34	6	18	3.8	100	4.4	100x120	MLC2900V697K#100120		
		69	13	39	1.0	40	4.0	100x125	MLC2900V697K#100125		
	710	57	10	30	1.6	50	3.8	88.5x159	MLC2900V717K#885159		
		48	14	42	1.3	60	6.5	140x70	MLC2900V717K#14070		
730	54	9	27	2.0	55	3.4	85x175	MLC2900V737K#85175			
	43	9	27	2.3	80	4.6	116x95	MLC2900V737K#11695			
780	69	13	39	1.1	40	3.7	100x135	MLC2900V787K#100135			
	48	14	42	1.4	65	6.0	140x75	MLC2900V787K#14075			
810	57	10	30	1.8	55	3.4	88.5x175	MLC2900V817K#885175			
820	53	9	27	2.3	60	3.0	85x197	MLC2900V827K#85197			
830	43	9	27	2.6	90	4.1	116x106	MLC2900V837K#116106			

* additional information for I_r on page 25

Additional designs on request · Weitere Designs auf Anfrage

Rated DC Voltage U_N Max ripple Voltage U_r Non repetitive Surge Volt. U_s	Nominal Capacitance C_N [μF]	Ripple Current at 50°C 1 k–10 kHz I_r^* [A RMS]	Peak Current Maximum value \hat{I} [kA]	Surge Current Maximum value I_s [kA]	ESR		Thermal Resistance		Case Size $D \times L$ [mm]	Product Code # = variable value, see fixing code in the product code
					ESR [mΩ]	ESL [nH]	R_{th} [K/W]			
900 VDC Ripple Voltage 200 V Surge Voltage 1350 V	860	68	13	39	1.2	45	3.5	100x145	MLC2900V867K#100145	
	870	47	14	42	1.5	65	5.9	140x80	MLC2900V877K#14080	
	910	56	10	30	2.1	60	3.0	88.5x197	MLC2900V917K#885197	
	930	68	13	39	1.4	50	3.0	100x159	MLC2900V937K#100159	
	940	80	18	54	0.9	40	3.4	116x125	MLC2900V947K#116125	
	960	52	9	27	2.7	70	2.7	85x225	MLC2900V967K#85225	
	970	42	9	27	3.0	100	3.7	116x120	MLC2900V977K#116120	
	980	47	14	42	1.6	75	5.5	140x87	MLC2900V987K#14087	
	1 000	54	9	27	2.6	70	2.6	88.5x225	MLC2900V108K#885225	
		66	12	36	1.6	55	2.8	100x175	MLC2900V108K#100175	
		79	17	51	0.9	40	3.5	116x135	MLC2900V108K#116135	
	1 100	64	13	39	1.8	60	2.7	100x197	MLC2900V118K#100197	
		78	17	51	1.0	45	3.2	116x145	MLC2900V118K#116145	
		46	13	39	1.8	80	5.1	140x95	MLC2900V118K#14095	
	1 200	100	17	51	1.0	50	2.8	116x159	MLC2900V128K#116159S	
		45	13	39	2.0	90	4.8	140x106	MLC2900V128K#140106	
	1 300	79	18	54	1.1	50	2.9	116x159	MLC2900V138K#116159	
	1 400	66	13	39	2.0	70	2.3	100x225	MLC2900V148K#100225	
		78	17	51	1.3	55	2.5	116x175	MLC2900V148K#116175	
		45	13	39	2.4	100	4.0	140x120	MLC2900V148K#140120	
		84	27	81	0.7	40	4.0	140x125	MLC2900V148K#140125	
	1 500	83	26	78	0.8	40	3.6	140x135	MLC2900V158K#140135	
	1 600	77	17	51	1.4	60	2.4	116x197	MLC2900V168K#116197	
	1 700	83	26	78	0.8	45	3.6	140x145	MLC2900V178K#140145	
	1 900	77	18	54	1.6	70	2.1	116x225	MLC2900V198K#116225	
		84	26	78	0.9	50	3.1	140x159	MLC2900V198K#140159	
	2 200	84	27	81	1.0	55	2.8	140x175	MLC2900V228K#140175	
	2 500	83	27	81	1.1	60	2.6	140x197	MLC2900V258K#140197	
2 900	81	27	81	1.3	70	2.3	140x225	MLC2900V298K#140225		

* additional information for I_r on page 25

Additional designs on request · Weitere Designs auf Anfrage

> Life Time Table · Brauchbarkeitsdauer – Tabelle

Lifetime as function of ratio between the effective working voltage U_w and the rated DC voltage U_N													
$T_{HOTSPOT}$	x 0.7	x 0.75	x 0.8	x 0.85	x 0.9	x 0.95	x 1.0	x 1.05	x 1.1	x 1.15	x 1.2	x 1.25	x 1.30
40°C	300	300	300	300	300	300	300	300	300	300	300	204	123
45°C	300	300	300	300	300	300	300	300	300	300	203	120	72
50°C	300	300	300	300	300	300	300	300	300	208	120	70	42
55°C	300	300	300	300	300	300	300	300	217	122	70	41	25
60°C	300	300	300	300	300	300	300	233	128	71	41	24	15
65°C	300	300	300	300	300	300	258	137	75	42	24	14	9
70°C	300	300	300	300	300	295	151	80	44	25	14	8	5
75°C	300	300	300	300	251	124	64	33	19	11	6	3.5	2
80°C	300	300	300	221	105	52	27	14	8	4	2.5	1.5	
85°C	300	199	86	39	19	9	5	2.5	1.5				

khrs value limited to 300 000 hours.

> Life Time Graph · Brauchbarkeitsdauer – Diagramm

Lifetime expectancy depending on hotspot temperature $T_{HOTSPOT}$ versus ratio between the effective working voltage U_w and the rated DC voltage U_N

Lebenserwartung in Abhängigkeit von der hotspot Temperatur $T_{HOTSPOT}$ und dem Verhältnis der tatsächlich anliegenden Spannung zur DC Nennspannung U_N

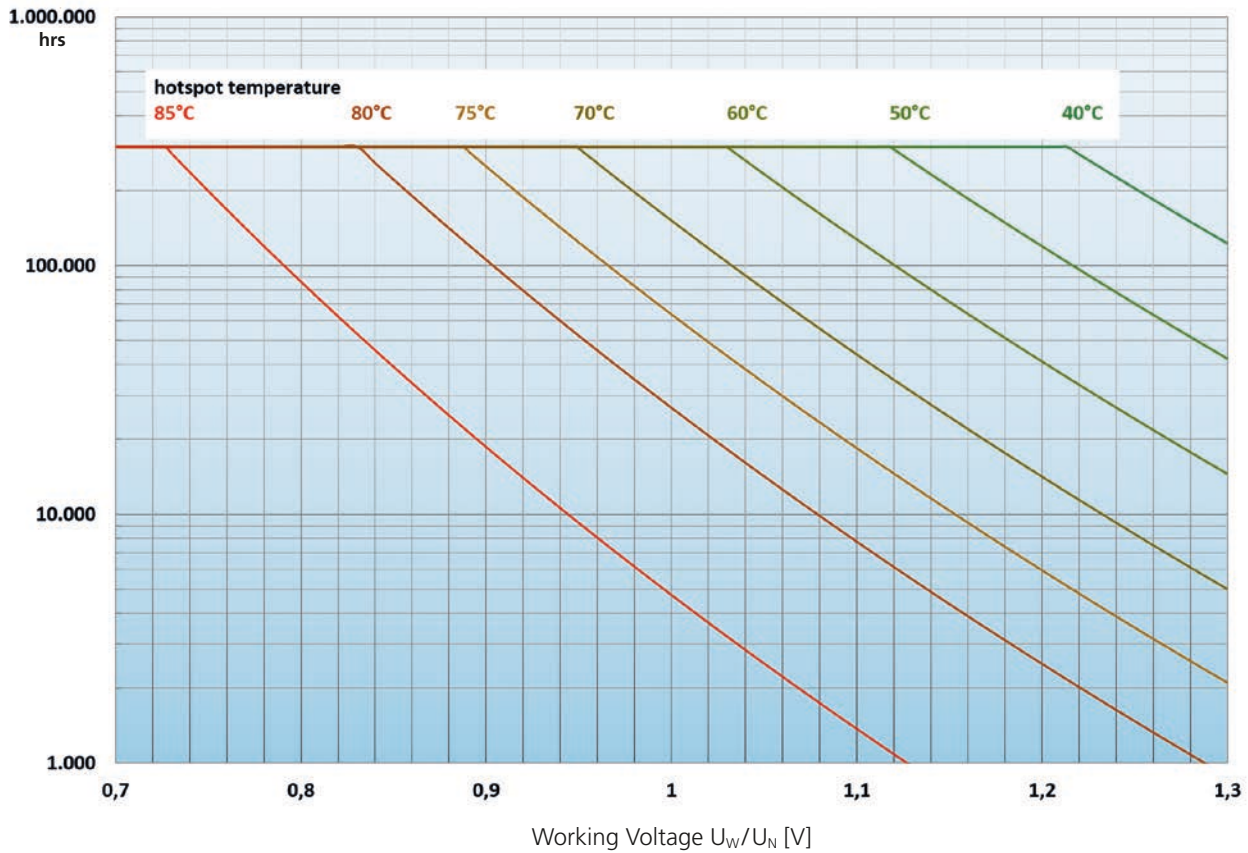

$$T_{HOTSPOT} = T_a + I^2 \times ESR \times R_{th}$$

MLCA · Screw-Terminal · 85 °C

High Voltage · High Ripple Current

> Specifications · Spezifikationen

Items	Characteristics
Temperature range	-40°C ~ +85 °C at 1.0xU _N
Rated Voltage U _N	600 ~ 2200Vdc (other available on request)
Capacitance tolerance	standard +/- 10 %, +/- 5 % on request
Voltage test between terminals U _{TT}	1.5 x U _N / 10 s
Voltage test terminals to case U _{TC}	≥ 3 000Vac / 10 s
Terminals	M6 x 10 (refer to p. 8)
Stud Bolt	M12 x 16 (refer to p. 8)
Life Time Test / Reference Standards	IEC 61071: 2017 / UL810 (E474687)
Life Time Expectancy	100 000 hrs (T _{HOTSPOT} 70 °C, 1.0 x U _N)
Failure Rate	<= 50 FIT = 50 x 10 ⁻⁹ Failures / hour
Dielectric	Polypropylene
Cap	PBT UL94V-0 listed
Case material	Aluminum
Climatic category (IEC 61071)	40/85/56
Product Compliance	RoHS, REACH, Conflict Minerals a.o. - refer to p.12–13



> Dimensions · Abmessungen

For details refer to p. 8 · Technische Details siehe S. 8

Dimensions (mm)	ØD			
	Ø 76	Ø 86	Ø 116 (L < 100)	Ø 116 (L > 100)
Shape Code for mounting	B, N	B, N	B, N	B, N
Cap Type	B	B	H	I
Terminal Pitch P	32	32	50	50
Diameter at Terminal Ø dT	12	12	14	14
Terminal Length T _L	5	5	5	5
Cap Length L _C	32	32	10	45
Optional Stud Bolt Length L _S	16	16	16	16
Permissible terminal current (Arms)	100	100	100	100

Cap style B

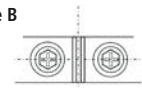

Cap style H, I

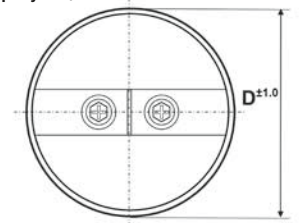

> Ripple Current Multiplier · I_r Strom Multiplikatoren

Temperature [°C]	40	45	50	55	60	65	70	75	80	85
Multiplier (1 kHz)	2.0	1.87	1.75	1.6	1.42	1.2	1.0	0.8	0.6	0.0

I_{max} is to be controlled below the permissible terminal current.

Please contact us if ripple current includes frequencies below 1 kHz and/or above 10 kHz.

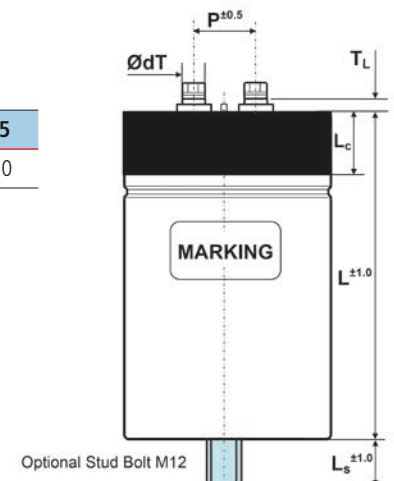

> Product Code · Bestellbezeichnung

Example: Series MLCA · 1100V · 2000 µF +/- 10 % · D = 116 mm · L = 345 mm with Stud Bolt

MLCA	1100V	208	K	B	116	345	I	
Series Name	Rated voltage xxxV	Capacitance code The first two digits are significant. The last digit indicates the number of following zeros in pF.	Capacitance tolerance K : ± 10 % J : ± 5 %	Shape code B : Stud Bolt N : plain bottom	Case Diameter ØD Length in mm	Case Length Length in mm	Cap type B, H, I	Specific features (...)

Rated DC Voltage U_N	Nominal Capacitance C_N [µF]	Ripple Current 1 kHz				Peak Current Maximum value \hat{I} [kA]	ESR [mΩ]	ESL [nH]	Thermal Resistance R_{th} [K/W]	Case Size $D \times L$ [mm]	Product Code
		at 40 °C I_r^* [A RMS]	at 50 °C I_r^* [A RMS]	at 60 °C I_r^* [A RMS]	at 70 °C I_r^* [A RMS]						
600 Vdc U_{TT} 900 Vdc/10s U_{TC} 3 000 Vac/10s	480	70	61	50	35	4.80	1.6	50	5.1	76x95	MLCA600V487K#7695B
	650	67	58	47	33	5.20	1.9	50	4.7	76x120	MLCA600V657K#76120B
		81	70	57	40	5.20	1.1	50	5.6	86x95	MLCA600V657K#8695B
	770	88	76	62	44	6.16	1.2	50	4.3	76x136	MLCA600V777K#76136B
	880	80	69	57	40	6.25	1.3	50	4.8	86x120	MLCA600V887K#86120B
	950	82	71	58	41	6.65	1.4	50	4.2	76x175	MLCA600V957K#76175B
	1000	93	81	66	46	6.70	1.0	50	4.6	86x136	MLCA600V108K#86136B
	1100	81	70	57	40	6.60	1.4	50	4.4	86x155	MLCA600V118K#86155B
	1200	96	83	68	48	7.20	0.8	50	5.4	116x95	MLCA600V128K#11695H
	1300	96	84	68	48	7.80	1.0	60	4.3	86x175	MLCA600V138K#86175B
	1600	94	82	67	47	9.60	0.9	60	5.0	116x120	MLCA600V168K#116120I
	1800	95	83	67	47	10.80	1.1	60	4.0	86x225	MLCA600V188K#86225B
	1900	86	75	61	43	11.40	1.1	60	4.9	116x136	MLCA600V198K#116136I
2100	100	100	85	60	11.55	0.6	60	4.6	116x155	MLCA600V218K#116155I	
2400	100	100	86	61	12.00	0.6	60	4.5	116x175	MLCA600V248K#116175I	
3000	100	100	96	68	15.00	0.8	60	2.7	116x230	MLCA600V308K#116230I	
5000	100	100	100	71	25.00	0.9	80	2.2	116x345	MLCA600V508K#116345I	
700 Vdc U_{TT} 1050 Vdc/10s U_{TC} 3 000 Vac/10s	350	70	61	50	35	3.60	1.6	50	5.1	76x95	MLCA700V357K#7695B
	480	64	55	45	31	3.84	2.1	50	4.7	76x120	MLCA700V487K#76120B
		71	62	51	36	3.84	1.4	50	5.6	86x95	MLCA700V487K#8695B
	580	60	52	43	30	5.80	2.4	50	4.6	76x136	MLCA700V587K#76136B
	620	79	68	56	39	6.20	1.5	50	4.3	76x155	MLCA700V627K#76155B
	700	77	67	55	38	7.20	1.6	50	4.2	76x175	MLCA700V707K#76175B
	750	66	57	47	32	7.20	2.0	50	4.6	86x136	MLCA700V757K#86136B
	780	68	59	48	33	7.80	1.9	50	4.6	86x136	MLCA700V787K#86136B
	920	100	89	73	51	9.20	0.7	50	5.4	116x95	MLCA700V927K#11695H
	950	79	68	56	39	9.50	1.5	60	4.3	86x175	MLCA700V957K#86175B
1200	89	77	63	44	7.20	1.0	60	5.0	116x120	MLCA700V128K#116120I	

* additional information for I, on page 31

Additional designs on request · Weitere Designs auf Anfrage

Rated DC Voltage U_N	Nominal Capacitance C_N [µF]	Ripple Current 1 kHz				Peak Current Maximum value \hat{I} [kA]	ESR [mΩ]	ESL [nH]	Thermal Resistance R_{th} [K/W]	Case Size $D \times L$ [mm]	Product Code
		at 40 °C I_r^* [A RMS]	at 50 °C I_r^* [A RMS]	at 60 °C I_r^* [A RMS]	at 70 °C I_r^* [A RMS]						
700 Vdc U_{TT} 1 050 Vdc/10 s U_{TC} 3 000 Vac/10 s	1 500	86	75	61	43	9.00	1.1	60	4.9	116x136	MLCA700V158K#116136I
		100	90	74	52	9.00	0.8	60	4.6	116x155	MLCA700V158K#116155I
	1 800	94	82	67	47	10.80	1.0	60	4.5	116x175	MLCA700V188K#116175I
		2 300	100	100	96	68	13.80	0.8	60	2.7	116x230
800 Vdc U_{TT} 1 200 Vdc/10 s U_{TC} 3 000 Vac/10 s	280	68	59	48	34	2.80	1.7	50	5.1	76x95	MLCA800V287K#7695B
	370	69	60	49	35	3.70	1.5	50	5.6	86x95	MLCA800V377K#8695B
	430	57	49	40	28	4.30	2.6	50	4.6	76x136	MLCA800V437K#76136B
	470	76	66	54	38	4.70	1.6	50	4.3	76x155	MLCA800V477K#76155B
	510	70	61	50	35	5.10	1.7	50	4.8	86x120	MLCA800V517K#86120B
	560	73	63	51	37	5.60	1.7	50	4.2	76x175	MLCA800V567K#76175B
	580	68	59	48	33	5.80	1.9	50	4.6	86x136	MLCA800V587K#86136B
	640	91	79	64	45	6.40	1.1	50	4.4	86x155	MLCA800V647K#86155B
	710	82	71	58	41	7.10	1.1	50	5.4	116x95	MLCA800V717K#11695H
	750	85	73	60	42	7.50	1.3	60	4.3	86x175	MLCA800V757K#86175B
	970	82	71	58	40	7.76	1.2	60	5.0	116x120	MLCA800V977K#116120I
		1 000	85	73	60	42	8.00	1.4	60	4.0	86x225
			76	66	54	38	8.00	1.4	60	4.9	116x136
	1 200	100	90	74	52	9.60	0.8	60	4.6	116x155	MLCA800V128K#116155I
	1 400	100	91	75	53	11.20	0.8	60	4.5	116x175	MLCA800V148K#116175I
	1 800	100	100	86	60	11.70	1.0	60	2.7	116x230	MLCA800V188K#116230I
3 300	100	100	100	71	19.80	0.9	80	2.2	116x345	MLCA800V338K#116345I	
900 Vdc U_{TT} 1 350 Vdc/10 s U_{TC} 3 000 Vac/10 s	280	63	54	44	31	2.80	2.0	50	5.1	76x95	MLCA900V287K#7695B
	370	67	58	47	33	3.70	1.6	50	5.6	86x95	MLCA900V377K#8695B
	380	56	49	40	28	3.80	2.6	50	4.7	76x120	MLCA900V387K#76120B
	430	55	47	39	27	4.30	2.9	50	4.6	76x136	MLCA900V437K#76136B
	470	74	64	52	36	4.70	1.7	50	4.3	76x155	MLCA900V477K#76155B
	510	68	59	48	34	5.10	1.8	50	4.8	86x120	MLCA900V517K#86120B
	560	69	60	49	34	5.60	2.0	50	4.2	76x175	MLCA900V567K#76175B
	580	64	56	46	32	5.80	2.1	50	4.6	86x136	MLCA900V587K#86136B
	640	87	75	62	43	6.40	1.2	50	4.4	86x155	MLCA900V647K#86155B
	710	79	68	56	39	7.10	1.2	50	5.4	116x95	MLCA900V717K#11695H
	750	82	71	58	40	7.50	1.4	60	4.3	86x175	MLCA900V757K#86175B
	970	78	68	55	39	7.60	1.3	60	5.0	116x120	MLCA900V977K#116120I
		1 000	82	71	58	40	8.00	1.5	60	4.0	86x225
			74	64	52	36	8.00	1.5	60	4.9	116x136
	1 200	93	81	66	47	9.60	1.0	60	4.6	116x155	MLCA900V128K#116155I
	1 400	99	86	70	50	11.20	0.9	60	4.5	116x175	MLCA900V148K#116175I
1 800	100	100	82	58	11.70	1.1	60	2.7	116x230	MLCA900V188K#116230I	
3 300	100	100	95	67	19.80	1.0	80	2.2	116x345	MLCA900V338K#116345I	
1 000 Vdc U_{TT} 1 500 Vdc/10 s U_{TC} 3 000 Vac/10 s	220	57	50	40	29	2.42	2.4	50	5.1	76x95	MLCA1000V227K#7695B
	290	65	56	46	32	3.19	1.7	50	5.6	86x95	MLCA1000V297K#8695B
	300	55	48	39	27	3.30	2.8	50	4.7	76x120	MLCA1000V307K#76120B
	330	54	47	38	26	3.63	3.0	50	4.6	76x136	MLCA1000V337K#76136B

* additional information for I_r on page 31

Additional designs on request · Weitere Designs auf Anfrage

MLCA · Screw-Terminal · 85 °C

Rated DC Voltage U_N	Nominal Capacitance	Ripple Current 1 kHz				Peak Current Maximum value \hat{I} [kA]	ESR [mΩ]	ESL [nH]	Thermal Resistance R_{th} [K/W]	Case Size $D \times L$ [mm]	Product Code # = variable value, see fixing code in the product code
		at 40 °C I_r^* [A RMS]	at 50 °C I_r^* [A RMS]	at 60 °C I_r^* [A RMS]	at 70 °C I_r^* [A RMS]						
1000 Vdc U_{TT} 1500 Vdc/10s U_{TC} 3000 Vac/10s	360	72	62	51	35	3.96	1.8	50	4.3	76x155	MLCA1000V367K#76155B
	400	66	57	47	33	4.40	1.9	50	4.8	86x120	MLCA1000V407K#86120B
	420	69	60	49	34	4.62	2.0	50	4.2	76x175	MLCA1000V427K#76175B
	450	64	56	46	32	4.95	2.1	50	4.6	86x136	MLCA1000V457K#86136B
	500	87	75	62	43	5.00	1.2	50	4.4	86x155	MLCA1000V507K#86155B
	540	79	68	56	39	5.40	1.2	50	5.4	116x95	MLCA1000V547K#11695H
	560	82	71	58	40	5.60	1.4	60	4.3	86x175	MLCA1000V567K#86175B
	740	79	68	55	39	7.40	1.3	60	5.0	116x120	MLCA1000V747K#116120I
	860	71	62	51	35	8.60	1.6	60	4.9	116x136	MLCA1000V867K#116136I
	900	98	85	70	49	8.76	0.9	60	4.6	116x155	MLCA1000V907K#116155I
	1100	99	86	70	50	8.80	0.9	60	4.5	116x175	MLCA1000V118K#116175I
	1400	100	100	82	58	11.20	1.1	60	2.7	116x230	MLCA1000V148K#116230I
2200	100	100	91	64	13.20	1.1	80	2.2	116x345	MLCA1000V228K#116345I	
1100 Vdc U_{TT} 1650 Vdc/10s U_{TC} 3000 Vac/10s	170	54	47	38	27	2.04	2.7	50	5.1	76x95	MLCA1100V177K#7695B
	240	52	45	37	26	2.88	3.1	50	4.7	76x120	MLCA1100V247K#76120B
		61	53	43	31	2.88	1.9	50	5.6	86x95	MLCA1100V247K#8695B
	270	51	44	36	25	3.24	3.4	50	4.6	76x136	MLCA1100V277K#76136B
	300	68	59	48	34	3.60	2.0	50	4.3	76x155	MLCA1100V307K#76155B
	320	62	53	44	31	3.84	2.2	50	4.8	86x120	MLCA1100V327K#86120B
	350	64	56	46	32	4.20	2.3	50	4.2	76x175	MLCA1100V357K#76175B
	360	89	77	66	45	2.50	1.0	60	4.4	86x155	MLCA1100V367K#86155B
	400	90	80	67	46	2.50	1.0	60	4.4	96x140	MLCA1100V407K#96140B
	420	60	52	43	30	5.04	2.4	50	4.6	86x136	MLCA1100V427K#86136B
	420	81	70	57	40	5.04	1.4	50	4.4	86x155	MLCA1100V427K#86155B
		75	65	53	37	5.40	1.3	50	5.4	116x95	MLCA1100V457K#11695H
	480	76	66	54	38	5.76	1.6	60	4.3	86x175	MLCA1100V487K#86175B
	500	100	100	80	48	3.70	0.65	40	3.6	116x140	MLCA1100V507K#116140I
	620	73	63	52	36	6.20	1.5	60	5.0	116x120	MLCA1100V627K#116120I
	650	75	65	53	37	6.50	1.8	60	4.0	86x225	MLCA1100V657K#86225B
	690	69	60	49	34	6.90	1.7	60	4.9	116x136	MLCA1100V697K#116136I
770	93	81	66	47	7.70	1.0	60	4.6	116x155	MLCA1100V777K#116155I	
910	94	82	67	47	9.10	1.0	60	4.5	116x175	MLCA1100V917K#116175I	
1200	100	96	79	55	9.60	1.2	60	2.7	116x230	MLCA1100V128K#116230I	
2000	100	100	84	59	16.00	1.3	80	2.2	116x345	MLCA1100V208K#116345I	
1200 Vdc U_{TT} 1800 Vdc/10s U_{TC} 3000 Vac/10s	140	51	44	36	26	1.68	3.0	50	5.1	76x95	MLCA1200V147K#7695B
	190	58	51	41	29	2.28	2.1	50	5.6	86x95	MLCA1200V197K#8695B
	200	50	43	35	25	2.40	3.4	50	4.7	76x120	MLCA1200V207K#76120B
	220	48	42	34	24	2.64	3.7	50	4.6	76x136	MLCA1200V227K#76136B
	240	65	56	46	32	2.88	2.2	50	4.3	76x155	MLCA1200V247K#76155B
	260	59	51	42	29	3.12	2.4	50	4.8	86x120	MLCA1200V267K#86120B
	280	62	53	44	30	3.36	2.5	50	4.2	76x175	MLCA1200V287K#76175B
	300	58	50	41	28	3.60	2.6	50	4.6	86x136	MLCA1200V307K#86136B
	330	78	67	55	38	3.96	1.5	50	4.4	86x155	MLCA1200V337K#86155B
	360	73	63	51	36	4.32	1.4	50	5.4	116x95	MLCA1200V367K#11695H
	380	72	62	51	35	4.56	1.8	60	4.3	86x175	MLCA1200V387K#86175B

* additional information for I_r on page 31

Additional designs on request · Weitere Designs auf Anfrage

Rated DC Voltage U_N	Nominal Capacitance	Ripple Current 1 kHz				Peak Current Maximum value \hat{I} [kA]	ESR [mΩ]	ESL [nH]	Thermal Resistance R_{th} [K/W]	Case Size $D \times L$ [mm]	Product Code # = variable value, see fixing code in the product code
		at 40 °C I_r^* [A RMS]	at 50 °C I_r^* [A RMS]	at 60 °C I_r^* [A RMS]	at 70 °C I_r^* [A RMS]						
1200 Vdc U_{TT} 1800 Vdc/10s U_{TC} 3000 Vac/10s	500	69	59	49	34	5.50	1.7	60	5.0	116x120	MLCA1200V507K#116120I
	540	71	61	50	35	5.94	2.0	60	4.0	86x225	MLCA1200V547K#86225B
	570	66	57	46	32	6.27	1.9	60	4.9	116x136	MLCA1200V577K#116136I
	620	89	77	63	44	6.82	1.1	60	4.6	116x155	MLCA1200V627K#116155I
	720	90	78	64	45	7.92	1.1	60	4.5	116x175	MLCA1200V727K#116175I
	950	100	92	75	53	9.50	1.3	60	2.7	116x230	MLCA1200V957K#116230I
	1600	100	100	95	67	16.00	1.0	80	2.2	116x345	MLCA1200V168K#116345I
1300 Vdc U_{TT} 1950 Vdc/10s U_{TC} 3000 Vac/10s	120	49	42	34	24	1.44	3.3	50	5.1	76x95	MLCA1300V127K#7695B
	160	48	42	34	23	1.92	3.7	50	4.7	76x120	MLCA1300V167K#76120B
		56	48	39	28	1.92	2.3	50	5.6	86x95	MLCA1300V167K#8695B
	180	46	40	33	23	2.16	4.1	50	4.6	76x136	MLCA1300V187K#76136B
	210	62	54	44	31	2.52	2.4	50	4.3	76x155	MLCA1300V217K#76155B
	220	57	49	40	28	2.64	2.6	50	4.8	86x120	MLCA1300V227K#86120B
	240	58	51	41	29	2.88	2.8	50	4.2	76x175	MLCA1300V247K#76175B
	250	55	47	39	27	3.00	2.9	50	4.6	86x136	MLCA1300V257K#86136B
	280	73	63	52	36	3.36	1.7	50	4.4	86x155	MLCA1300V287K#86155B
	310	68	59	48	34	3.72	1.6	50	5.4	116x95	MLCA1300V317K#11695H
	320	70	61	49	34	3.84	1.9	60	4.3	86x175	MLCA1300V327K#86175B
	420	67	58	47	33	5.04	1.8	60	5.0	116x120	MLCA1300V427K#116120I
	450	67	58	48	33	5.40	2.2	60	4.0	86x225	MLCA1300V457K#86225B
	480	62	54	44	31	5.76	2.1	60	4.9	116x136	MLCA1300V487K#116136I
	530	89	77	63	44	6.36	1.1	60	4.6	116x155	MLCA1300V537K#116155I
600	66	57	50	32	7.2	2.3	60	4.0	86x250	MLCA1300V607K#86250B	
630	90	78	64	45	7.56	1.1	60	4.5	116x175	MLCA1300V637K#116175I	
820	99	86	70	49	9.84	1.5	60	2.7	116x230	MLCA1300V827K#116230I	
1400	100	100	87	61	15.40	1.2	80	2.2	116x345	MLCA1300V148K#116345I	
1500 Vdc U_{TT} 2250 Vdc/10s U_{TC} 3000 Vac/10s	140	57	50	40	28	1.4	2.6	50	4.6	86x136	MLCA1500V147K#86136B
	170	52	45	37	26	2.04	3.1	50	4.8	86x120	MLCA1500V177K#86120B
	175	88	76	62	40	4.0	1.0	60	4.0	86x137	MLCA1500V177J#86137B
	210	67	58	48	33	2.52	2.0	50	4.4	86x155	MLCA1500V217K#86155B
	310	62	53	44	30	3.72	2.1	60	5.0	116x120	MLCA1500V317K#116120I
	330	63	55	45	31	3.96	2.5	60	4.0	86x225	MLCA1500V337K#86225B
	400	79	68	56	39	4.80	1.4	60	4.6	116x155	MLCA1500V407K#116155I
	600	93	81	66	46	7.20	1.7	60	2.7	116x230	MLCA1500V607K#116230I
1000	100	100	95	67	12.00	1.0	80	2.2	116x345	MLCA1500V108K#116345I	
1700 Vdc U_{TT} 2250 Vdc/10s U_{TC} 4000 Vac/10s	130	49	42	35	24	1.56	3.5	50	4.8	86x120	MLCA1700V137K#86120B
	160	63	54	44	31	1.92	2.3	50	4.4	86x155	MLCA1700V167K#86155B
	240	58	50	41	28	2.88	2.4	60	5.0	116x120	MLCA1700V247K#116120I
	250	59	51	42	29	3.00	2.9	60	4.0	86x225	MLCA1700V257K#86225B
	300	74	64	52	37	3.60	1.6	60	4.6	116x155	MLCA1700V307K#116155I
	460	91	79	64	45	5.52	1.8	60	2.7	116x230	MLCA1700V467K#116230I
2000 Vdc U_{TT} 3000 Vdc/10s U_{TC} 4000 Vac/10s	100	46	40	32	23	1.20	4.0	50	4.8	86x120	MLCA2000V107K#86120B
	120	60	52	43	30	1.44	2.5	50	4.4	86x155	MLCA2000V127K#86155B
	190	54	47	38	27	2.28	2.7	60	5.0	116x120	MLCA2000V197K#116120I
		55	48	39	27	2.28	3.3	60	4.0	86x225	MLCA2000V197K#86225B

* additional information for I_r on page 31

Additional designs on request · Weitere Designs auf Anfrage

Rated DC Voltage U_N	Nominal Capacitance C_N [μ F]	Ripple Current 1 kHz				Peak Current Maximum value \hat{I} [kA]	ESR [m Ω]	ESL [nH]	Thermal Resistance R_{th} [K/W]	Case Size $D \times L$ [mm]	Product Code
		at 40 °C I_r^* [A RMS]	at 50 °C I_r^* [A RMS]	at 60 °C I_r^* [A RMS]	at 70 °C I_r^* [A RMS]						
2000 Vdc U_{TT} 3000 Vdc/10s U_{TC} 4000 Vac/10s	240	70	60	49	35	2.88	1.8	60	4.6	116x155	MLCA2000V247K#116155I
	370	82	71	58	41	4.44	2.2	60	2.7	116x230	MLCA2000V377K#116230I
	600	100	100	87	61	6.00	1.2	80	2.2	116x345	MLCA2000V607K#116345I
2200 Vdc U_{TT} 3300 Vdc/10s U_{TC} 4000 Vac/10s	90	48	42	34	24	1.08	3.7	50	4.6	86x136	MLCA2200V906K#86136B
	140	60	52	43	30	1.68	2.2	60	5.0	116x120	MLCA2200V147K#116120I
	150	73	63	51	36	1.80	1.9	60	4.0	86x225	MLCA2200V157K#86225B
	170	59	51	42	29	2.04	2.5	60	4.6	116x155	MLCA2200V177K#116155I
	210	90	78	64	45	2.52	1.1	60	4.5	116x175	MLCA2200V217K#116175I
	290	100	89	73	51	3.48	1.4	60	2.7	116x230	MLCA2200V297K#116230I
	450	100	100	87	61	5.40	1.2	80	2.2	116x345	MLCA2200V457K#116345I

* additional information for I_r on page 31

Additional designs on request · Weitere Designs auf Anfrage

> Life Time Graph · Brauchbarkeitsdauer – Diagramm

Lifetime expectancy depending on hotspot temperature $T_{HOTSPOT}$ versus ratio between the effective working voltage U_w and the rated DC voltage U_N

Lebenserwartung in Abhängigkeit von der hotspot Temperatur $T_{HOTSPOT}$ und dem Verhältnis der tatsächlich anliegenden Spannung zur DC Nennspannung U_N

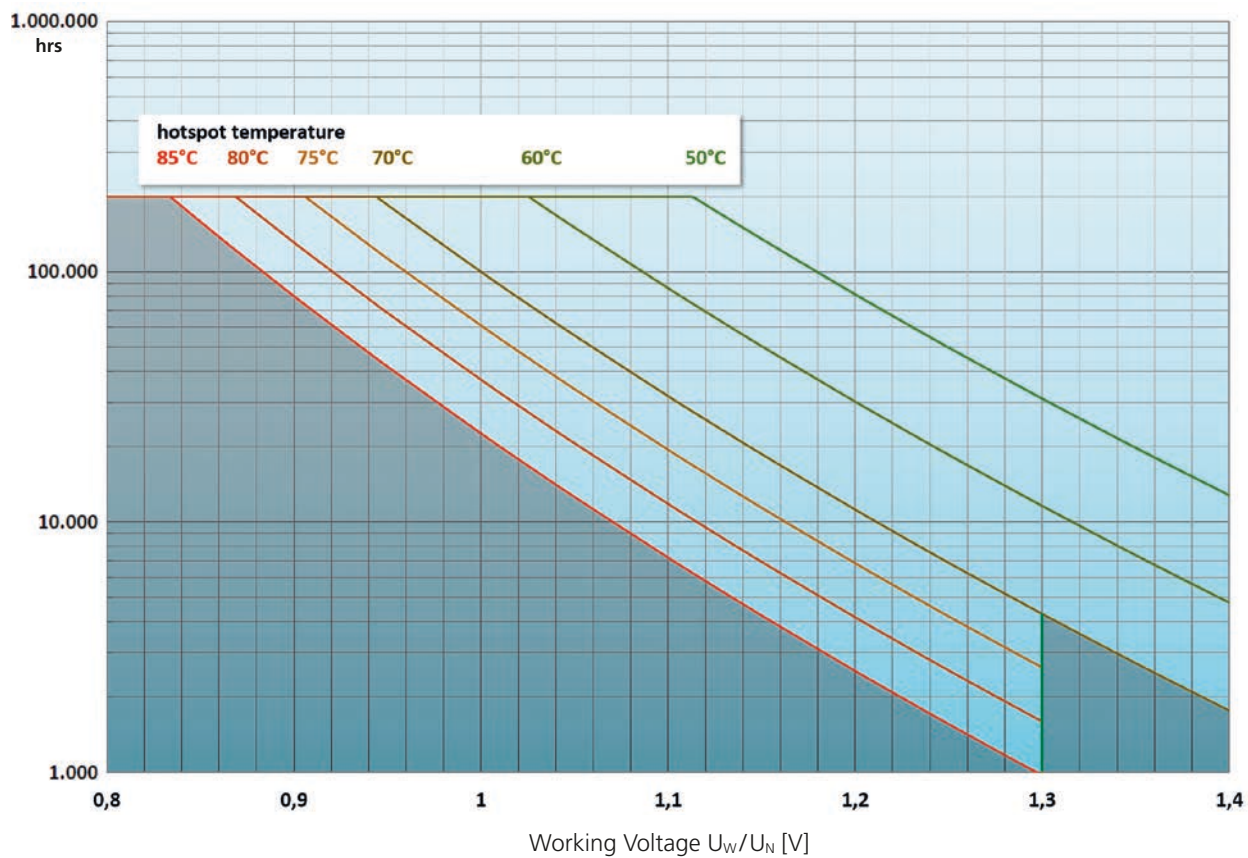

$$T_{HOTSPOT} = T_a + I^2 \times ESR \times R_{th}$$

PCB mount Series Data

MKCA · MKCHA · MKCP4 · MKCP4T



MKCA · PCB mount · 105 °C

Resin-encased box type · Standard Performances · Optional THB-types on request

> Specifications · Spezifikationen

Items	Characteristics
Temperature range	-40 °C ~ +105 °C voltage derating when hotspot temp ≥ 85 °C
Rated Voltage U_N	450, 700, 1100Vdc at 85 °C other rated voltage on request
Voltage test between terminals U_{TT}	$1.5 \times U_N / 10s$
Maximum ripple Voltage U_{AC} peak to peak	$0.2 \times U_N$ 85 °C
Terminals	tinned wired leads
Life Time Test / Reference Standards	IEC 61071: 2017/UL810 (E474687)
Life Time Expectancy	115 000 hrs ($T_{HOTSPOT}$ 70 °C, $1.0 \times U_N$)
Failure Rate	≤ 50 FIT = 50×10^{-9} Failures / hour
Dielectric	Polypropylene
Safety function	Self healing film
Case material	PBT conform to UL94V-0
Filling material	resin conform to UL94V-0
Product Compliance	RoHS, REACH, Conflict Minerals a.o. - refer to p.12–13



> Dimensions · Abmessungen

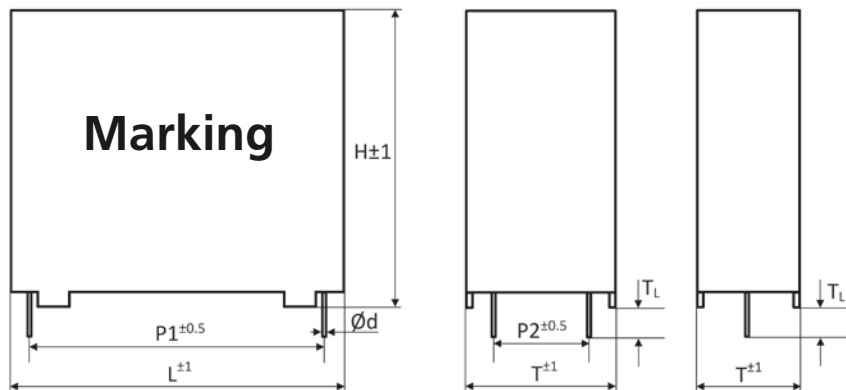

internal circuit

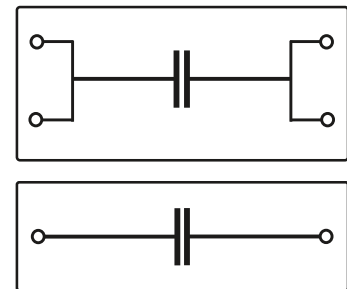

For details refer to p. 9
Technische Details siehe S. 9

> Voltage and current derating vs. temperature · Spannung und Strom Abstufung

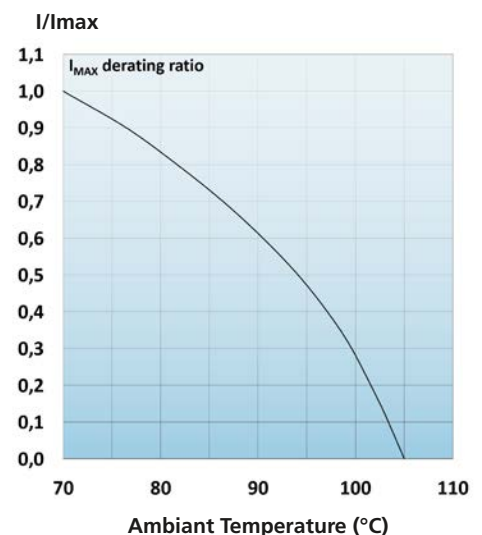
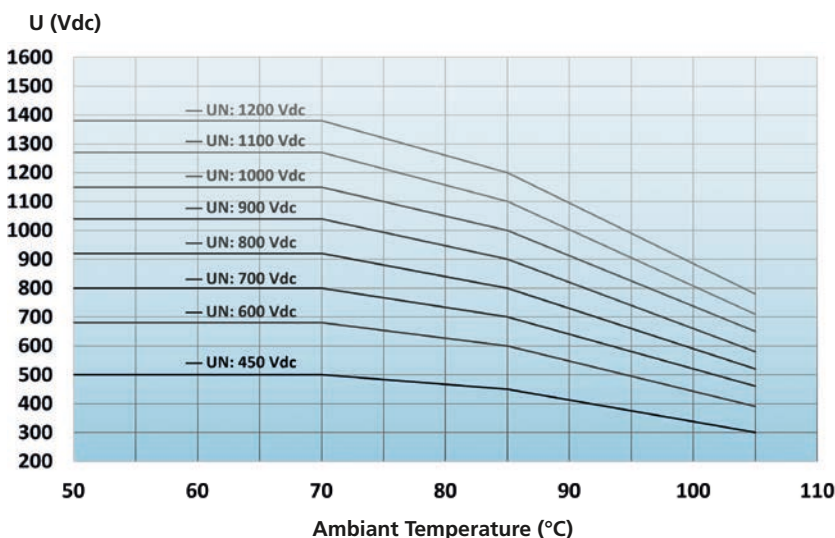

> Case Code · Gehäuse Codierung

Example: MKCA 700Vdc · 80µF · T=35.0mm, H=60.0mm, L=57.5mm, 4 pins Ø1.2x5.0
 Product Code MKCA700V806K**MP3**4ED

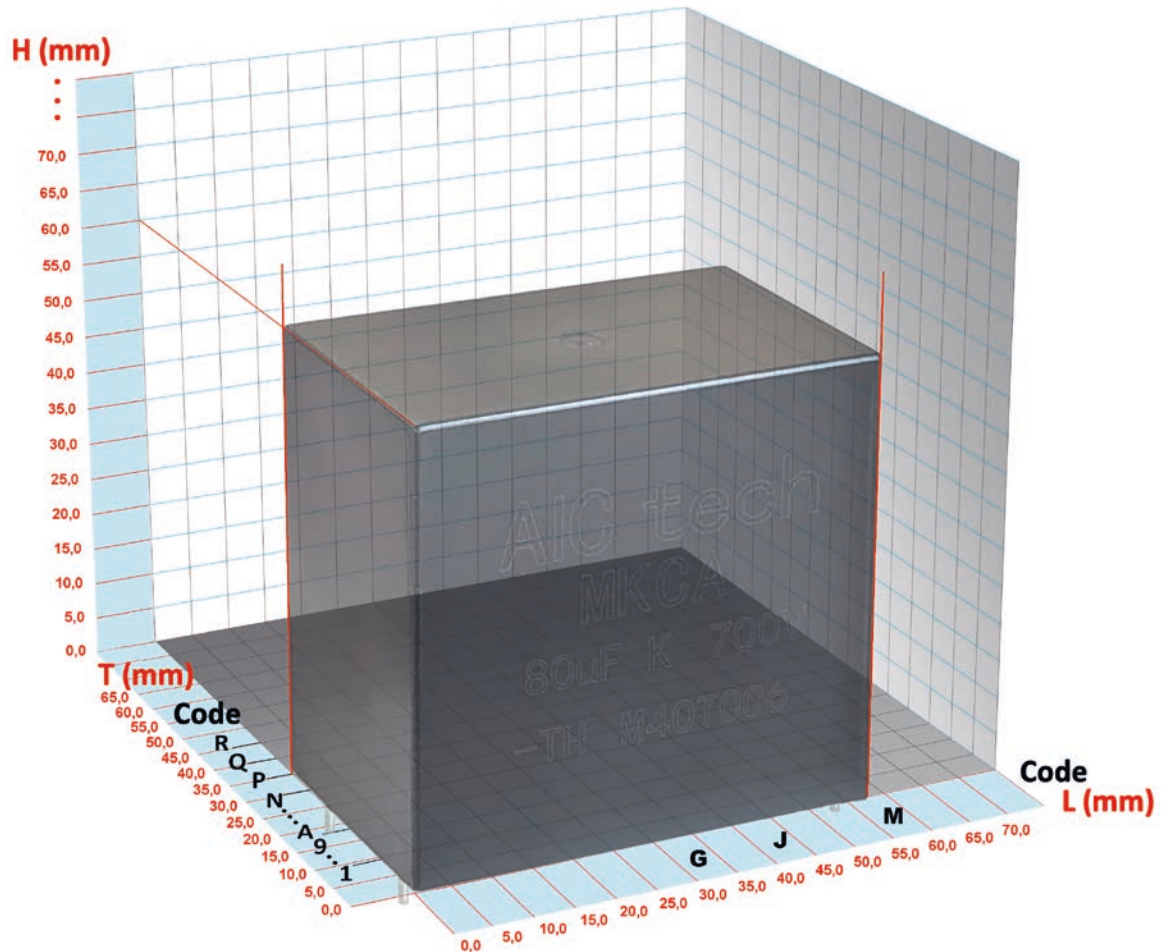

Case dimension code	Case (mm)			Case dimension code	Case (mm)		
	T	H	L		T	H	L
G10	9.0	18.0	32.0	JN0	30.0	45.0	42.5
G30	11.0	20.0	32.0	JP0	35.0	50.0	42.5
G50	13.0	22.0	32.0	MH0	25.0	45.0	57.5
G60	14.0	28.0	32.0	MN0	30.0	45.0	57.5
G70	15.0	28.5	32.0	MP0	35.0	45.0	57.5
GA0	18.0	28.0	32.0	MP1	35.0	50.0	57.5
GA1	18.0	33.0	32.0	MP2	35.0	55.0	57.5
GE0	22.0	37.0	32.0	MP3	35.0	60.0	57.5
JB0	19.0	32.0	42.5	MP4	35.0	65.0	57.5
JC0	20.0	40.0	42.5	MP5	35.0	70.0	57.5
JE0	22.0	33.5	42.5	MP6	35.0	75.0	57.5
JE1	22.0	37.0	42.5	MP7	35.0	80.0	57.5
JG0	24.0	18.0	42.5	MR0	45.0	55.0	57.5
JG1	24.0	44.0	42.5	MR1	45.0	60.0	57.5
JL0	28.0	37.0	42.5	MR2	45.0	65.0	57.5

Wire Length (mm)	
Length	Code
3.0	A
3.5	B
4.0	C
4.5	D
5.0	E
5.5	F
6.0	G

Wire diam. (mm)	
Ød	Code
0.6	A
0.8	B
1.0	C
1.2	D

Additional designs on request · Weitere Designs auf Anfrage

> Product Code · Bestellbezeichnung

Example: Series MKCA · 700V · 80µF +/- 10% · T=35mm · H=60mm · L = 57.5mm · 4 pins Ø 1.2x5.0

MKCA

Type of series

700V

Rated voltage xxxV

806

Capacitance code

The first two digits are significant.
The last digit indicates the number
of following zeros in pF.

K

Capacitance tolerance

K : ± 10 %

J : ± 5 %

MP3

Case Code

4ED

Pin Code

Rated DC Voltage U_N derating Voltage test between terminals U_T	Nominal Capacitance C_N [µF]	Ripple Current at 70 °C 1 k–10 kHz I_r [A RMS]	Peak Current Maximum value \hat{I} [A]	ESR ESR [mΩ]	Thermal Resist. R_{th} [K/W]	dv/dt [V/µs]	Dimensions			Product Code	
							Case Size $T \times H \times L$ [mm]	Terminals $P1$ [mm] $P2$ [mm] $\varnothing d$ [mm]			
450Vdc at 85 °C 500Vdc at 70 °C 300Vdc at 105 °C U_T 650Vdc / 10s	3	4.0	150	28.0	41.3	50	11x20x32	27.5	–	0.8	MKCA450V305KG302EB
	5	6.0	250	14.0	35.6	50	13x22x32	27.5	–	0.8	MKCA450V505KG502EB
	10	10.0	500	8.0	22.5	50	18x33x32	27.5	–	0.8	MKCA450V106KGA12EB
		12.0	750	6.5	18.5	50	22x37x32	27.5	–	0.8	MKCA450V156KGE02EB
	15	13.0	750	5.5	18.5	50	22x37x32	27.5	10.2	0.8	MKCA450V156KGE04EB
		12.5	600	6.5	16.6	30	20x40x42.5	37.5	10.2	1	MKCA450V206KJC04EC
	22	13.5	660	6.5	16.6	30	20x40x42.5	37.5	10.2	1	MKCA450V226KJC04EC
	30	15.0	900	6.0	14.1	30	24x44x42.5	37.5	10.2	1	MKCA450V306KJG14EC
	35	16.5	1050	5.8	12.2	30	30x45x42.5	37.5	20.3	1.2	MKCA450V356KJN04ED
	40	17.0	1200	5.5	12.2	30	30x45x42.5	37.5	20.3	1.2	MKCA450V406KJN04ED
	50	19.5	1500	5.0	10.4	30	35x50x42.5	37.5	20.3	1.2	MKCA450V506KJP04ED
60	17.0	900	6.8	9.8	15	30x45x57.5	52.5	20.3	1.2	MKCA450V606KMN04ED	
75	20.0	1125	5.0	8.4	15	35x50x57.5	52.5	20.3	1.2	MKCA450V756KMP14ED	
600Vdc at 85 °C 680Vdc at 70 °C 390Vdc at 105 °C U_T 900Vdc / 10 s	3	3.5	150	31.8	41.3	50	11x20x32	27.5	–	0.8	MKCA600V305KG302EB
	4	4.5	200	23.9	41.3	50	11x20x32	27.5	–	0.8	MKCA600V405KG302EB
	5	6.0	250	14.5	28.8	50	14x28x32	27.5	–	0.8	MKCA600V505KG602EB
	10	8.5	500	9.7	22.5	50	18x33x32	27.5	–	0.8	MKCA600V106KGA12EB
	15	10.5	750	9.0	18.5	50	22x37x32	27.5	–	0.8	MKCA600V156KGE02EB
	20	11.0	600	9.8	16.6	30	20x40x42.5	37.5	10.2	1	MKCA600V206KJC04EC
	30	13.0	900	5.5	14.6	30	28x37x42.5	37.5	10.2	1	MKCA600V306KJL04EC
	40	17.5	1200	5.2	12.2	30	30x45x42.5	37.5	20.3	1.2	MKCA600V406KJN04ED
	50	14.0	750	6.5	8.4	15	35x50x57.5	52.5	20.3	1.2	MKCA600V506KMP14ED
	60	16.0	900	6.0	8.4	15	35x50x57.5	52.5	20.3	1.2	MKCA600V606KMP14ED
70	20.5	1050	5.6	8.4	15	35x50x57.5	52.5	20.3	1.2	MKCA600V706KMP14ED	
700Vdc at 85 °C 800Vdc at 70 °C 460Vdc at 105 °C U_T 1050Vdc / 10 s	1	2.5	50	54.0	48.7	50	9x18x32	27.5	–	0.8	MKCA700V105KG102EB
	3.3	5.0	165	26.0	28.8	50	14x28x32	27.5	–	0.8	MKCA700V335KG602EB
	5	5.5	250	16.0	28.8	50	14x28x32	27.5	–	0.8	MKCA700V505KG602EB
	6	6.0	300	14.0	25.3	50	18x28x32	27.5	–	0.8	MKCA700V605KGA02EB
	8	9.0	400	10.0	22.5	50	18x33x32	27.5	–	0.8	MKCA700V805KGA12EB
	10	12.0	500	6.5	18.5	50	22x37x32	27.5	–	0.8	MKCA700V106KGE02EB
	12	12.5	600	6.0	18.5	50	22x37x32	27.5	–	0.8	MKCA700V126KGE02EB
		9.0	450	9.0	17.9	30	22x33.5x42.5	37.5	–	1	MKCA700V156KJE02EC
	15	10.0	450	8.0	17.9	30	22x33.5x42.5	37.5	10.2	1	MKCA700V156KJE04EC

Additional designs on request · Weitere Designs auf Anfrage

Rated DC Voltage U_N derating Voltage test between terminals U_{TT}	Nominal Capacitance C_N [μ F]	Ripple Current at 70 °C 1 k–10 kHz I_r [A RMS]	Peak Current Maximum value \hat{I} [A]	ESR ESR [m Ω]	Thermal Resist. R_{th} [K/W]	dv/dt [V/ μ s]	Dimensions				Product Code
							Case Size $T \times H \times L$ [mm]		Terminals		
							P1 [mm]	P2 [mm]	$\varnothing d$ [mm]		
700 Vdc at 85 °C 800Vdc at 70 °C 460Vdc at 105 °C U_{TT} 1050Vdc / 10 s	15	10.0	450	8.0	16.6	30	20x40x42.5	37.5	10.2	1	MKCA700V156KJC04EC
	20	12.0	600	7.5	14.6	30	28x37x42.5	37.5	10.2	1	MKCA700V206KJL04EC
	22	14.0	660	6.5	14.1	30	24x44x42.5	37.5	10.2	1	MKCA700V226KJG14EC
	25	15.0	750	6.0	14.1	30	24x44x42.5	37.5	10.2	1	MKCA700V256KJG14EC
	30	16.0	900	5.8	12.2	30	30x45x42.5	37.5	20.3	1.2	MKCA700V306KJN04ED
	35	18.5	1050	5.5	10.4	30	35x50x42.5	37.5	20.3	1.2	MKCA700V356KJP04ED
	40	14.0	600	6.2	9.8	15	30x45x57.5	52.5	20.3	1.2	MKCA700V406KMN04ED
	45	15.5	675	5.1	9.8	15	30x45x57.5	52.5	20.3	1.2	MKCA700V456KMN04ED
	50	15.0	750	4.8	8.4	15	35x50x57.5	52.5	20.3	1.2	MKCA700V506KMP14ED
	55	16.0	825	4.5	8.4	15	35x50x57.5	52.5	20.3	1.2	MKCA700V556KMP14ED
	60	18.0	900	4.2	8.4	15	35x50x57.5	52.5	20.3	1.2	MKCA700V606KMP14ED
80	23.0	1200	3.5	7.3	15	35x60x57.5	52.5	20.3	1.2	MKCA700V806KMP34ED	
800 Vdc at 85 °C 920Vdc at 70 °C 520Vdc at 105 °C U_{TT} 1200Vdc / 10 s	1	2.0	50	62.0	48.7	50	9x18x32	27.5	–	0.8	MKCA800V105KG102EB
	2	3.5	100	31.0	41.3	50	11x20x32	27.5	–	0.8	MKCA800V205KG302EB
	3	4.0	150	25.0	35.6	50	13x22x32	27.5	–	0.8	MKCA800V305KG502EB
	3.3	4.5	165	21.0	28.8	50	14x28x32	27.5	–	0.8	MKCA800V335KG602EB
	5	7.0	250	14.0	28.8	50	14x28x32	27.5	–	0.8	MKCA800V505KG602EB
	6	7.5	300	13.5	25.3	50	18x28x32	27.5	–	0.8	MKCA800V605KGA02EB
	8	8.0	400	12.5	22.5	50	18x33x32	27.5	–	0.8	MKCA800V805KGA12EB
	9	8.5	450	11.1	22.5	50	18x33x32	27.5	–	0.8	MKCA800V905KGA12EB
	10	9.5	500	11.0	18.5	50	22x37x32	27.5	–	0.8	MKCA800V106KGE02EB
		8.0	300	12.5	20	30	19x32x42.5	37.5	–	1	MKCA800V106KJB02EC
	15	10.0	450	11.9	16.6	30	20x40x42.5	37.5	10.2	1	MKCA800V156KJC04EC
	20	12.0	600	8.9	14.6	30	28x37x42.5	37.5	10.2	1	MKCA800V206KJL04EC
		12.5	600	8.9	14.1	30	24x44x42.5	37.5	10.2	1	MKCA800V206KJG14EC
	22	14.0	660	6.0	14.1	30	24x44x42.5	37.5	10.2	1	MKCA800V226KJG14EC
	25	15.0	750	6.0	12.2	30	30x45x42.5	37.5	20.3	1.2	MKCA800V256KJN04ED
	30	16.5	900	5.9	12.2	30	30x45x42.5	37.5	20.3	1.2	MKCA800V306KJN04ED
	35	12.0	525	9.5	9.8	15	30x45x57.5	52.5	20.3	1.2	MKCA800V356KMN04ED
	40	13.5	600	8.9	9.8	15	30x45x57.5	52.5	20.3	1.2	MKCA800V406KMN04ED
	45	15.0	675	7.9	9.8	15	30x45x57.5	52.5	20.3	1.2	MKCA800V456KMN04ED
	50	16.5	750	7.1	8.4	15	35x50x57.5	52.5	20.3	1.2	MKCA800V506KMP14ED
55	18.5	825	6.5	8.4	15	35x50x57.5	52.5	20.3	1.2	MKCA800V556KMP14ED	
65	19.0	975	5.5	7.3	15	35x60x57.5	52.5	20.3	1.2	MKCA800V656KMP34ED	
70	20.0	1050	5.1	7.3	15	35x60x57.5	52.5	20.3	1.2	MKCA800V706KMP34ED	
75	22.0	1125	4.8	6.9	15	35x65x57.5	52.5	20.3	1.2	MKCA800V756KMP44ED	
900 Vdc at 85 °C 1040Vdc at 70 °C 580Vdc at 105 °C U_{TT} 1350Vdc / 10 s	1	1.5	50	86.0	48.7	50	9x18x32	27.5	–	0.8	MKCA900V105KG102EB
	2	3.0	100	43.0	41.3	50	11x20x32	27.5	–	0.8	MKCA900V205KG302EB
	3	4.0	150	28.7	35.6	50	13x22x32	27.5	–	0.8	MKCA900V305KG502EB
	3.3	4.5	165	26.5	30.6	50	15x24.5x32	27.5	–	0.8	MKCA900V335KG702EB
	5	5.5	250	22.5	25.3	50	18x28x32	27.5	–	0.8	MKCA900V505KGA02EB
	6	6.5	300	18.0	22.5	50	18x33x32	27.5	–	0.8	MKCA900V605KGA12EB
	8	8.5	400	13.5	18.5	50	22x37x32	27.5	–	0.8	MKCA900V805KGE02EB

Additional designs on request · Weitere Designs auf Anfrage

Rated DC Voltage U_N derating Voltage test between terminals U_{TT}	Nominal Capacitance C_N [μF]	Ripple Current	Peak Current	ESR	Thermal Resist.	dv/dt	Dimensions			Product Code	
		at 70 °C 1 k–10 kHz	Maximum value				Case Size $T \times H \times L$ [mm]	Terminals			
		I_r [A RMS]	\hat{I} [A]	ESR [mΩ]	R_{th} [K/W]	[V/μs]		P1 [mm]	P2 [mm]		Ød [mm]
900Vdc at 85 °C 1040Vdc at 70 °C 580Vdc at 105 °C U_{TT} 1350Vdc/ 10 s	10	9.0	500	12.0	18.5	50	22x37x32	27.5	–	0.8	MKCA900V106KGE02EB
		7.0	300	16.7	16.6	30	20x40x42.5	37.5	–	1	MKCA900V106KJC02EC
		7.0	300	16.7	16.6	30	20x40x42.5	37.5	10.2	1	MKCA900V106KJC04EC
	15	10.5	450	11.1	14.1	30	24x44x42.5	37.5	–	1	MKCA900V156KJG12EC
		12.0	540	9.3	14.1	30	24x44x42.5	37.5	–	1	MKCA900V186KJG12EC
	18	12.0	540	9.3	14.1	30	24x44x42.5	37.5	10.2	1	MKCA900V186KJG14EC
		13.5	600	8.5	12.2	30	30x45x42.5	37.5	–	1	MKCA900V206KJN02EC
	20	13.5	600	8.5	12.2	30	30x45x42.5	37.5	20.3	1.2	MKCA900V206KJN04ED
		15.5	750	6.7	12.2	30	30x45x42.5	37.5	20.3	1.2	MKCA900V256KJN04ED
	25	18.5	900	5.6	10.4	30	35x50x42.5	37.5	20.3	1.2	MKCA900V306KJP04ED
		10.5	450	11.1	9.8	15	30x45x57.5	52.5	20.3	1.2	MKCA900V306KMN04ED
	35	13.5	525	9.5	8.4	15	35x50x57.5	52.5	20.3	1.2	MKCA900V356KMP14ED
	40	14.0	600	8.4	8.4	15	35x50x57.5	52.5	20.3	1.2	MKCA900V406KMP14ED
	50	17.5	750	6.7	8.4	15	35x50x57.5	52.5	20.3	1.2	MKCA900V506KMP14ED
55	19.0	825	6.1	7.3	15	35x60x57.5	52.5	20.3	1.2	MKCA900V556KMP34ED	
60	22.0	900	5.6	6.9	15	35x65x57.5	52.5	20.3	1.2	MKCA900V606KMP44ED	
1000Vdc at 85 °C 1150Vdc at 70 °C 650Vdc at 105 °C U_{TT} 1500Vdc/ 10 s	1	2.5	70	45.0	41.3	70	11x20x32	27.5	–	0.8	MKCA1000V105KG302EB
	2	3.5	140	38.2	35.6	70	13x22x32	27.5	–	0.8	MKCA1000V205KG502EB
	3	5.0	210	25.5	30.6	70	15x24.5x32	27.5	–	0.8	MKCA1000V305KG702EB
	5	7.5	350	15.3	22.5	70	18x33x32	27.5	–	0.8	MKCA1000V505KGA12EB
	8	9.0	560	13.0	18.5	70	22x37x32	27.5	–	0.8	MKCA1000V805KGE02EB
		6.5	350	15.6	16.6	35	20x40x42.5	37.5	–	1	MKCA1000V106KJC02EC
	10	6.5	350	15.6	16.6	35	20x40x42.5	37.5	10.2	1	MKCA1000V106KJC04EC
		10.0	420	13.0	14.1	35	24x44x42.5	37.5	10.2	1	MKCA1000V126KJG14EC
	12	11.5	525	10.4	14.1	35	24x44x42.5	37.5	–	1	MKCA1000V156KJG12EC
		11.5	525	10.4	14.1	35	24x44x42.5	37.5	10.2	1	MKCA1000V156KJG14EC
	15	12.5	525	10.4	12.2	35	30x45x42.5	37.5	20.3	1.2	MKCA1000V156KJN04ED
		14.0	700	7.8	12.2	35	30x45x42.5	37.5	20.3	1.2	MKCA1000V206KJN04ED
	20	17.5	875	6.2	10.4	35	35x50x42.5	37.5	20.3	1.2	MKCA1000V256KJP04ED
	25	11.5	510	10.4	9.8	17	30x45x57.5	52.5	20.3	1.2	MKCA1000V306KMN04ED
	30	13.5	595	8.9	8.4	17	35x50x57.5	52.5	20.3	1.2	MKCA1000V356KMP14ED
	35	15.0	680	7.8	8.4	17	35x50x57.5	52.5	20.3	1.2	MKCA1000V406KMP14ED
		17.0	680	7.8	7.3	17	35x60x57.5	52.5	20.3	1.2	MKCA1000V406KMP34ED
40	19.0	850	6.2	6.9	17	35x65x57.5	52.5	20.3	1.2	MKCA1000V506KMP44ED	
1100Vdc at 85 °C 1270Vdc at 70 °C 710Vdc at 105 °C U_{TT} 1650Vdc/ 10 s	1	1.5	70	80.0	41.3	70	11x20x32	27.5	–	0.8	MKCA1100V105KG302EB
	2	4.0	140	25.0	30.6	70	15x24.5x32	27.5	–	0.8	MKCA1100V205KG702EB
	2.2	5.0	154	18.5	28.8	70	14x28x32	27.5	–	0.8	MKCA1100V225KG602EB
	4	7.5	280	15.3	22.5	70	18x33x32	27.5	–	0.8	MKCA1100V405KGA12EB
	5	8.5	350	14.0	18.5	70	22x37x32	27.5	–	0.8	MKCA1100V505KGE02EB
	6.8	6.0	272	20.5	17.9	40	22x33.5x42.5	37.5	10.2	1	MKCA1100V685KJE04EC
		7.5	320	18.1	16.6	40	20x40x42.5	37.5	–	1	MKCA1100V805KJC02EC
	8	7.5	320	18.1	16.6	40	20x40x42.5	37.5	10.2	1	MKCA1100V805KJC04EC
		6.5	320	18.1	16.7	40	22x37x42.5	37.5	10.2	1	MKCA1100V805KJE14EC

Additional designs on request · Weitere Designs auf Anfrage

Rated DC Voltage U_N derating Voltage test between terminals U_{TT}	Nominal Capacitance C_N [μ F]	Ripple Current at 70 °C 1 k–10 kHz I_r [A RMS]	Peak Current Maximum value \hat{I} [A]	ESR ESR [m Ω]	Thermal Resist. R_{th} [K/W]	dv/dt [V/ μ s]	Dimensions				Product Code
							Case Size		Terminals		
							$T \times H \times L$ [mm]	P1 [mm]	P2 [mm]	$\varnothing d$ [mm]	
1100 Vdc at 85 °C 1270Vdc at 70 °C 710Vdc at 105 °C U_{TT} 1650Vdc / 10 s	9	7.5	360	16.1	16.7	40	22x37x42.5	37.5	10.2	1	MKCA1100V905KJE14EC
	10	8.0	400	14.5	14.1	40	24x44x42.5	37.5	–	1	MKCA1100V106KJG12EC
		8.0	400	14.5	14.1	40	24x44x42.5	37.5	10.2	1	MKCA1100V106KJG14EC
	12	11.5	480	12.1	12.2	40	30x45x42.5	37.5	20.3	1.2	MKCA1100V126KJN04ED
	15	12.0	600	9.7	12.2	40	30x45x42.5	37.5	20.3	1.2	MKCA1100V156KJN04ED
	18	14.5	720	8.1	10.4	40	35x50x42.5	37.5	20.3	1.2	MKCA1100V186KJP04ED
	20	8.0	400	14.5	9.8	20	30x45x57.5	52.5	20.3	1.2	MKCA1100V206KMN04ED
	25	10.0	500	11.6	8.4	20	35x50x57.5	52.5	20.3	1.2	MKCA1100V256KMP14ED
	30	12.0	600	9.7	8.4	20	35x50x57.5	52.5	20.3	1.2	MKCA1100V306KMP14ED
	35	16.0	700	5.5	7.3	20	35x60x57.5	52.5	20.3	1.2	MKCA1100V356KMP34ED
40	17.0	800	4.9	6.9	20	35x65x57.5	52.5	20.3	1.2	MKCA1100V406KMP44ED	
1200 Vdc at 85 °C 1380Vdc at 70 °C 780Vdc at 105 °C U_{TT} 1800Vdc / 10 s	1	3.5	80	39.5	41.3	80	11x20x32	27.5	–	0.8	MKCA1200V105KG302EB
	2.2	5.5	176	17.0	25.3	80	18x28x32	27.5	–	0.8	MKCA1200V225KGA02EB
	3	7.0	240	16.0	25.3	80	18x28x32	27.5	–	0.8	MKCA1200V305KGA02EB
	3.3	8.0	264	13.5	22.5	80	18x33x32	27.5	–	0.8	MKCA1200V335KGA12EB
	5	9.0	400	12.7	18.5	80	22x37x32	27.5	–	0.8	MKCA1200V505KGE02EB
		6.0	225	22.3	17.9	45	22x33.5x42.5	37.5	–	1	MKCA1200V505KJE02EC
	6	6.5	270	18.6	16.6	45	20x40x42.5	37.5	–	1	MKCA1200V605KJC02EC
	7	7.5	315	15.9	16.7	45	22x37x42.5	37.5	10.2	1	MKCA1200V705KJE14EC
	8	8.5	360	13.9	14.1	45	24x44x42.5	37.5	10.2	1	MKCA1200V805KJG14EC
	10	10.5	450	11.1	14.1	45	24x44x42.5	37.5	10.2	1	MKCA1200V106KJG14EC
		12.0	450	11.1	12.2	45	30x45x42.5	37.5	20.3	1.2	MKCA1200V106KJN04ED
	15	16.0	675	7.4	10.4	45	35x50x42.5	37.5	20.3	1.2	MKCA1200V156KJP04ED
	20	10.0	460	11.9	9.8	23	30x45x57.5	52.5	20.3	1.2	MKCA1200V206KMN04ED
	25	12.5	575	9.6	8.4	23	35x50x57.5	52.5	20.3	1.2	MKCA1200V256KMP14ED
30	16.0	690	8.0	7.3	23	35x60x57.5	52.5	20.3	1.2	MKCA1200V306KMP34ED	

Additional designs on request · Weitere Designs auf Anfrage

> Life Time Table · Brauchbarkeitsdauer – Tabelle

Lifetime as function of ratio between the effective working voltage U_w and the rated DC voltage U_N													
$T_{HOTSPOT}$	x 0.5	x 0.6	x 0.7	x 0.75	x 0.8	x 0.85	x 0.9	x 0.95	x 1.0	x 1.05	x 1.1	x 1.15	x 1.20
50 °C	250	250	250	250	250	250	250	250	250	250	181	116	76
60 °C	250	250	250	250	250	250	250	250	234	144	91	58	38
70 °C	250	250	250	250	250	250	250	196	117	72	45	29	19
75 °C	250	250	250	250	250	250	238	138	83	51	32	21	
80 °C	250	250	250	250	250	250	168	98	59	36	23		
85 °C	250	250	250	250	250	210	119	69	42				
90 °C	250	250	250	228	132	79	48	30					
95 °C	250	250	114	70	45	30							
100 °C	200	75	32	22	16								
105 °C	34	17	9										

khrs value limited to 250 000 hours.

> Life Time Graph · Brauchbarkeitsdauer – Diagramm

Lifetime expectancy depending on hotspot temperature T_{HOTSPOT} versus ratio between the effective working voltage U_W and the rated DC voltage U_N

Lebenserwartung in Abhängigkeit von der hotspot Temperatur T_{HOTSPOT} und dem Verhältnis der tatsächlich anliegenden Spannung zur DC Nennspannung U_N

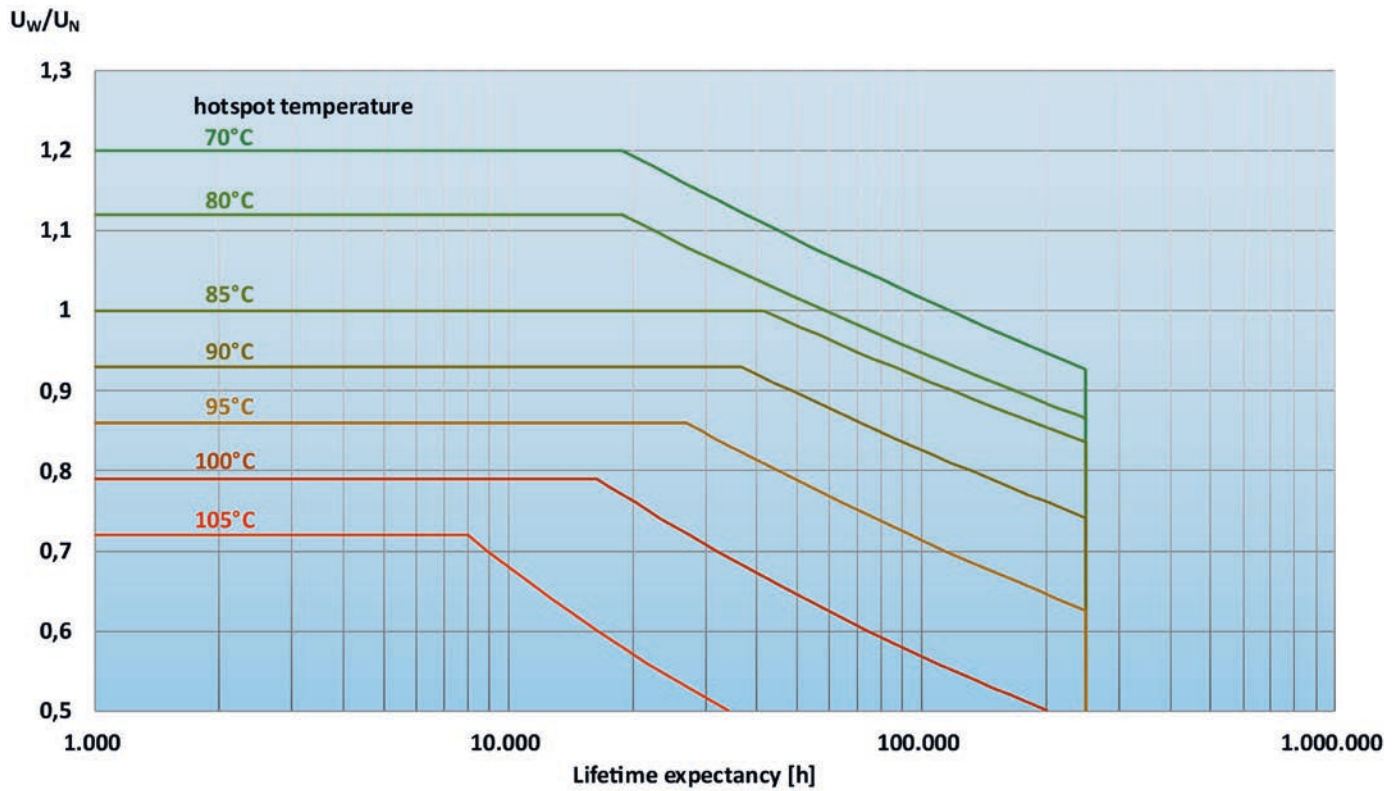

$$T_{\text{HOTSPOT}} = T_a + I^2 \times \text{ESR} \times R_{\text{th}}$$

MKCHA · PCB mount · 105 °C

Resin-encased box type · Standard Performances · Optional THB-types on request

> Specifications · Spezifikationen

Items	Characteristics
Temperature range	-40 °C ~ +105 °C 40/105/56 (IEC 61071)
Rated Voltage U_N	450 to 1.500 Vdc at 85 °C voltage derating when hotspot temp ≥ 85 °C
Voltage test between terminals U_{TT}	$1.5 \times U_N / 10$ s
Maximum ripple Voltage U_{AC} peak to peak	$0.2 \times U_N$ 85 °C
Terminals	tinned wired leads
Life Time Test / Standard	IEC 61071:2007
Life Time Expectancy	117 000 hrs ($T_{HOTSPOT}$ 70 °C, $1.0 \times U_N$)
Failure Rate	≤ 50 FIT = 50×10^{-9} Failures / hour
Dielectric	Polypropylene
Safety function	Self healing film
Case material	PBT conform to UL94V-0
Filling material	resin conform to UL94V-0
Product Compliance	RoHS, REACH, Conflict Minerals a.o. - refer to p.12-13



> Dimensions · Abmessungen

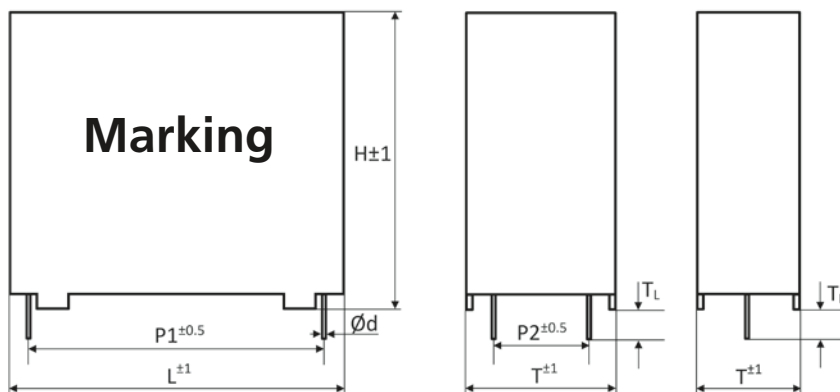

internal circuit

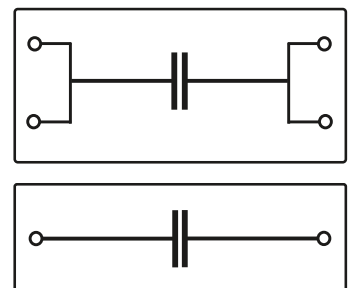

For details refer to p. 9
Technische Details siehe S. 9

> Voltage and current derating vs. temperature · Spannung und Strom Abstufung

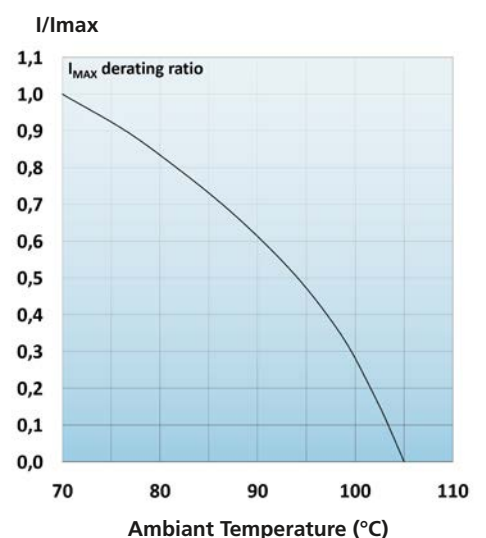
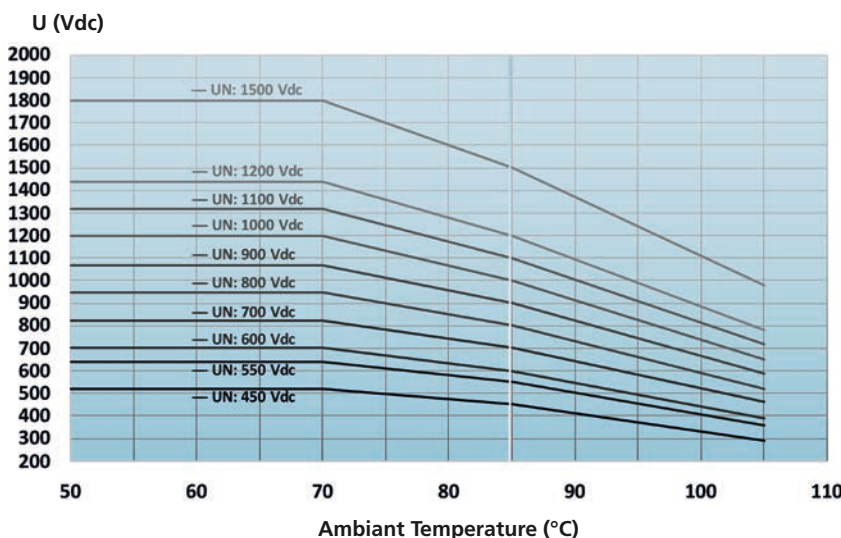

> Case Code · Gehäuse Codierung

Capacitor : MKCHA, 700V, 80µF±10%, T = 35.0 mm, H = 60.0 mm, L = 57.5 mm

Product Code : MKCHA-700V806KHMLAD

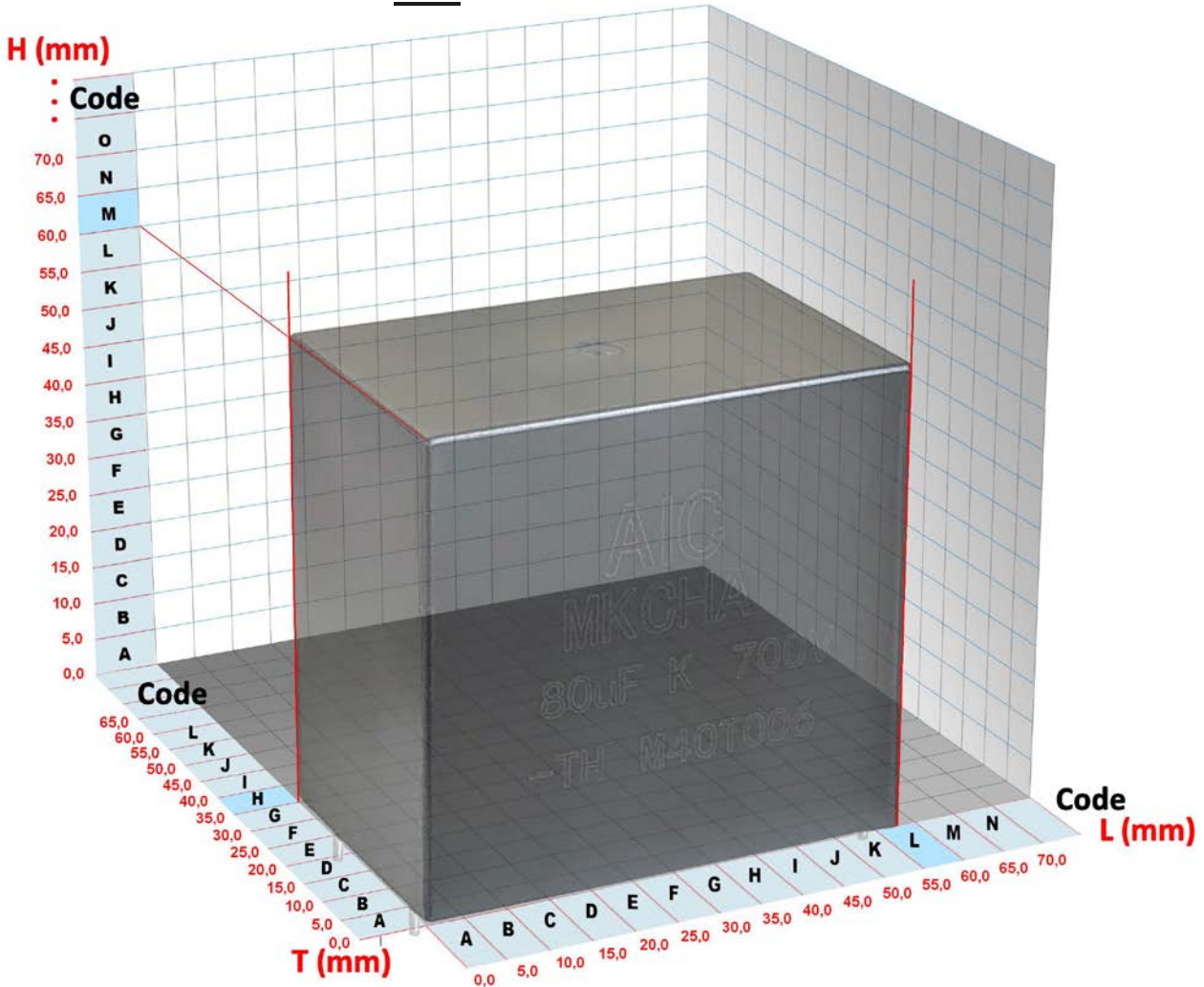

Case dimension code	Case (mm)			Terminals (mm)	
	T	H	L	P1	P2
DGI	16.0	31.0	41.0	37.5	5.0
	18.0	32.0	42.0	37.5	10.2
ECG	20.0	14.0	31.5	27.5	5.0
EHI	21.5	38.5	43.0	37.5	10.2
EGI	23.0	34.0	43.0	37.5	10.2
EII	24.0	44.0	42.0	37.5	10.2
FJL	25.0	45.0	57.5	52.5	10.2
FEI	27.0	21.0	42.0	37.5	10.2
FHI	27.0	36.0	41.0	37.5	10.2
FII	28.0	42.5	42.0	37.5	10.2
	29.0	44.0	41.0	37.5	15.0
GJI	30.0	45.0	42.0	37.5	20.3
GJL	30.0	45.0	57.5	52.5	20.3
GLI	30.0	55.0	42.0	37.5	20.3

Case dimension code	Case (mm)			Terminals (mm)	
	T	H	L	P1	P2
HEL	35.0	24.0	57.5	52.5	20.3
HKL	35.0	50.0	57.5	52.5	20.3
HML	35.0	60.0	57.5	52.5	20.3
HNL	35.0	65.0	57.5	52.5	20.3
HQL	35.0	80.0	57.5	52.5	20.3
HEL	39.0	24.0	57.5	52.5	20.3
IEL	43.0	22.0	57.5	52.5	20.3
JEI	45.0	21.0	42.0	37.5	20.3
JLL	45.0	57.0	57.5	52.5	20.3
JNL	45.0	65.0	57.5	52.5	20.3
MJL	60.0	45.0	57.5	52.5	20.3

Additional designs on request · Weitere Designs auf Anfrage

Rated DC Voltage U_N derating Voltage test between terminals U_{TT}	Nominal Capacitance C_N [μ F]	Ripple Current at 70°C 1k–10kHz I_r [A RMS]	Peak Current Maximum value \hat{I} [A]	ESR ESR [m Ω]	Thermal Resist. R_{th} [K/W]	dv/dt [V/ μ s]	Dimensions			Product Code	
							Case Size		Terminals		
							L x H x T [mm]	P1 [mm]	P2 [mm]		$\varnothing d$ [mm]
550 Vdc at 85°C 640 Vdc at 70 °C 360 Vdc at 105 °C U_{TT} 825 Vdc/10s	3	3.9	150	28.5	21.9	50	32 x 20 x 11	27.5	\	0.8	MKCHA-550V305KCEGGB
	5	5.9	250	14.5	19.4	50	32 x 22 x 13	27.5	\	0.8	MKCHA-550V505KCEGGB
	8	8.3	400	12.5	10.9	50	32 x 28 x 14	27.5	\	0.8	MKCHA-550V805KCFGGB
	10	9.8	500	8.0	12.3	50	32 x 33 x 18	27.5	\	0.8	MKCHA-550V106KDGGGB
	15	11.8	750	6.5	10.5	50	32 x 37 x 22	27.5	\	0.8	MKCHA-550V156KEHGGB
		12.8	750	5.5	10.6	50	32 x 37 x 22	27.5	10.2	0.8	MKCHA-550V156KEHGAB
	20	12.3	600	6.5	9.6	30	42.5 x 40 x 20	37.5	10.2	1	MKCHA-550V206KEIAC
	22	13.3	660	6.5	8.3	30	42.5 x 40 x 20	37.5	10.2	1	MKCHA-550V226KEIAC
	25	14.3	750	6.5	7.2	30	42.5 x 40 x 20	37.5	10.2	1	MKCHA-550V256KEIAC
	30	15.8	900	6.0	6.4	30	42.5 x 44 x 24	37.5	10.2	1	MKCHA-550V306KEIAC
	35	17.8	1050	6.0	5.0	30	42.5 x 45 x 30	37.5	20.3	1.2	MKCHA-550V356KGJIAD
	40	17.8	1200	5.5	5.5	30	42.5 x 45 x 30	37.5	20.3	1.2	MKCHA-550V406KGJIAD
	50	19.8	1500	5.0	5.0	30	42.5 x 50 x 35	37.5	20.3	1.2	MKCHA-550V506KHKIAD
	60	17.9	900	5.0	6.3	15	57.5 x 45 x 30	37.5	20.3	1.2	MKCHA-550V606KGJLAD
	75	19.9	1125	5.0	5.0	15	57.5 x 50 x 35	52.5	20.3	1.2	MKCHA-550V756KHKLAD
	100	24.0	1500	4.5	3.9	15	57.5 x 55 x 45	52.5	20.3	1.2	MKCHA-550V107KJLLAD
	110	26.1	1650	4.0	3.7	15	57.5 x 53 x 50	52.5	20.3	1.2	MKCHA-550V117KKKLAD
130	23.1	1950	3.5	5.6	15	57.5 x 60 x 35	52.5	20.3	1.2	MKCHA-550V137KHMLAD	
140	25.2	2100	3.0	4.8	15	57.5 x 65 x 35	52.5	20.3	1.2	MKCHA-550V147KHNLAD	
150	27.3	2250	3.0	4.4	15	57.5 x 70 x 35	52.5	20.3	1.2	MKCHA-550V157KHOLAD	
160	29.3	2400	3.0	4.0	15	57.5 x 80 x 35	52.5	20.3	1.2	MKCHA-550V167KHQLAD	
170	32.4	2550	2.5	3.5	15	57.5 x 80 x 35	52.5	20.3	1.2	MKCHA-550V177KHQLAD	
600 Vdc at 85°C 700 Vdc at 70 °C 390 Vdc at 105 °C U_{TT} 900 Vdc/10s	3	3.9	150	28.5	21.9	50	32 x 20 x 11	27.5	\	0.8	MKCHA-600V305KCEGGB
	4	4.9	200	26.5	15.1	50	32 x 20 x 11	27.5	\	0.8	MKCHA-600V405KCEGGB
	5	5.9	250	14.5	18.9	50	32 x 28 x 14	27.5	\	0.8	MKCHA-600V505KCFGGB
	8	7.4	400	12.0	14.6	50	32 x 28 x 14	27.5	\	0.8	MKCHA-600V805KCFGGB
	10	8.4	500	7.5	18.2	50	32 x 33 x 18	27.5	\	0.8	MKCHA-600V106KDGGGB
	12	9.4	600	7.5	14.6	50	32 x 33 x 18	27.5	\	0.8	MKCHA-600V126KDGGGB
		7.9	360	9.5	16.2	30	42.5 x 18 x 24	37.5	\	1	MKCHA-600V126KEDIBC
	15	10.4	750	7.5	11.9	50	32 x 37 x 22	27.5	\	0.8	MKCHA-600V156KEHGGB
		11.9	750	6.0	11.5	50	42.5 x 18 x 24	37.5	\	1	MKCHA-600V156KEDIBC
	20	10.9	600	6.0	13.7	30	42.5 x 40 x 20	37.5	10.2	1	MKCHA-600V206KEIAC
	30	13.0	900	5.5	10.7	30	42.5 x 37 x 28	37.5	10.2	1	MKCHA-600V306KFHAC
	35	16.6	1050	5.0	7.3	30	42.5 x 44 x 24	37.5	10.2	1	MKCHA-600V356KEIAC
	40	17.8	1200	4.0	7.7	30	42.5 x 45 x 30	37.5	20.3	1.2	MKCHA-600V406KGJIAD
	50	13.9	750	6.5	7.8	15	57.5 x 50 x 35	52.5	20.3	1.2	MKCHA-600V506KHKLAD
	60	15.9	900	5.0	7.9	15	57.5 x 50 x 35	52.5	20.3	1.2	MKCHA-600V606KHKLAD
	70	17.9	1050	5.0	6.3	15	57.5 x 50 x 35	52.5	20.3	1.2	MKCHA-600V706KHKLAD
	80	19.9	1200	4.0	6.4	15	57.5 x 55 x 45	52.5	20.3	1.2	MKCHA-600V806KJLLAD
	90	24.0	1350	4.0	4.4	15	57.5 x 55 x 45	52.5	20.3	1.2	MKCHA-600V906KJLLAD
	100	26.0	1500	4.0	3.8	15	57.5 x 53 x 50	52.5	20.3	1.2	MKCHA-600V107KKKLAD
	110	28.1	1650	3.5	3.7	15	57.5 x 53 x 50	52.5	20.3	1.2	MKCHA-600V117KKKLAD
120	30.1	1800	3.5	3.4	15	57.5 x 60 x 35	52.5	20.3	1.2	MKCHA-600V127KHMLAD	
130	32.2	1950	3.0	3.1	15	57.5 x 65 x 35	52.5	20.3	1.2	MKCHA-600V137KHNLAD	
140	34.3	2100	3.0	2.8	15	57.5 x 70 x 35	52.5	20.3	1.2	MKCHA-600V147KHOLAD	
	34.3	2100	3.0	2.8	15	57.5 x 65 x 45	52.5	20.3	1.2	MKCHA-600V147KJNLAD	
150	36.4	2250	3.0	2.7	15	57.5 x 80 x 35	52.5	20.3	1.2	MKCHA-600V157KHQLAD	

Rated DC Voltage U_N derating Voltage test between terminals U_{TT}	Nominal Capacitance C_N [μ F]	Ripple Current at 70 °C 1 k–10 kHz I_r [A RMS]	Peak Current Maximum value \hat{I} [A]	ESR ESR [m Ω]	Thermal Resist. R_{th} [K/W]	dv/dt [V/ μ s]	Dimensions			Product Code	
							Case Size		Terminals		
							L x H x T [mm]	P1 [mm]	P2 [mm]		$\varnothing d$ [mm]
700 Vdc at 85 °C 820 Vdc at 70 °C 460 Vdc at 105 °C U_{TT} 1050 Vdc/10s	1	2.5	75	55.0	29.0	75	32 x 18 x 9	27.5	\	0.8	MKCHA-700V105KBDGGB
	2	2.9	150	35.5	31.1	75	32 x 18 x 9	27.5	\	0.8	MKCHA-700V205KBDGGB
	3	4.4	150	28.5	17.3	50	32 x 20 x 11	27.5	\	0.8	MKCHA-700V305KCEGGB
	3,3	5.4	165	26.5	12.5	50	32 x 28 x 14	27.5	\	0.8	MKCHA-700V335KCFGGB
	5	5.9	250	14.5	19.4	50	32 x 28 x 14	27.5	\	0.8	MKCHA-700V505KCFGGB
	6	5.9	450	14.5	19.4	75	32 x 28 x 18	27.5	\	0.8	MKCHA-700V605KDFGGB
	8	8.8	400	10.0	12.1	50	32 x 33 x 18	27.5	\	0.8	MKCHA-700V805KDGGGB
	10	9.8	500	7.0	14.0	50	32 x 33 x 18	27.5	\	0.8	MKCHA-700V106KDGGGB
		11.8	500	6.5	10.5	50	32 x 37 x 22	27.5	\	0.8	MKCHA-700V106KEHGGB
	12	11.3	300	7.5	9.9	30	42.5 x 18 x 24	37.5	\	1	MKCHA-700V106KEDIBC
		11.8	600	6.0	10.5	50	32 x 37 x 22	27.5	\	0.8	MKCHA-700V126KEHGGB
	15	11.8	360	7.0	9.7	30	42.5 x 18 x 24	37.5	\	1	MKCHA-700V126KEDIBC
		8.8	450	9.0	13.5	30	42.5 x 33.5 x 22	37.5	\	1	MKCHA-700V156KEGIBC
	20	9.8	450	8.0	12.3	30	42.5 x 33.5 x 22	37.5	10.2	1	MKCHA-700V156KEGIAC
		9.8	450	8.0	12.3	30	42.5 x 40 x 20	37.5	10.2	1	MKCHA-700V156KEIAC
	22	11.8	600	7.5	9.2	30	42.5 x 37 x 28	37.5	10.2	1	MKCHA-700V206KFHIAC
	25	13.8	660	6.5	7.7	30	42.5 x 44 x 24	37.5	10.2	1	MKCHA-700V226KEIAC
	30	15.8	750	6.0	6.4	30	42.5 x 44 x 24	37.5	10.2	1	MKCHA-700V256KEIAC
	35	15.8	900	6.0	6.6	30	42.5 x 45 x 30	37.5	20.3	1.2	MKCHA-700V306KGJIAD
	40	19.7	1050	5.5	4.4	30	42.5 x 50 x 35	37.5	20.3	1.2	MKCHA-700V356KHKIAD
	45	13.8	600	5.0	10.1	15	57.5 x 45 x 30	52.5	20.3	1.2	MKCHA-700V406KGJLAD
	50	15.3	675	5.0	8.2	15	57.5 x 45 x 30	52.5	20.3	1.2	MKCHA-700V456KGJLAD
	55	14.9	750	5.0	9.2	15	57.5 x 50 x 35	52.5	20.3	1.2	MKCHA-700V506KHKLAD
	60	15.9	825	4.5	8.6	15	57.5 x 50 x 35	52.5	20.3	1.2	MKCHA-700V556KHKLAD
	65	17.9	900	4.0	7.6	15	57.5 x 50 x 35	52.5	20.3	1.2	MKCHA-700V606KHKLAD
	70	19.9	975	4.0	6.3	15	57.5 x 55 x 45	52.5	20.3	1.2	MKCHA-700V656KJLLAD
	75	19.9	1050	4.0	6.6	15	57.5 x 55 x 45	52.5	20.3	1.2	MKCHA-700V706KJLLAD
	80	19.9	1125	4.0	6.6	15	57.5 x 55 x 45	52.5	20.3	1.2	MKCHA-700V756KJLLAD
		21.9	1200	3.5	5.9	15	57.5 x 53 x 50	52.5	20.3	1.2	MKCHA-700V806KKKLAD
	90	22.9	1200	3.5	5.6	15	57.5 x 60 x 35	52.5	20.3	1.2	MKCHA-700V806KHMLAD
24.0		1350	3.5	5.0	15	57.5 x 53 x 50	52.5	20.3	1.2	MKCHA-700V906KKKLAD	
100	24.0	1350	3.5	5.0	15	57.5 x 60 x 35	52.5	20.3	1.2	MKCHA-700V906KHMLAD	
	26.0	1500	3.5	4.2	15	57.5 x 53 x 50	52.5	20.3	1.2	MKCHA-700V107KKKLAD	
110	26.0	1500	3.5	4.2	15	57.5 x 65 x 35	52.5	20.3	1.2	MKCHA-700V107KHNLAD	
	28.1	1650	3.5	3.8	15	57.5 x 70 x 35	52.5	20.3	1.2	MKCHA-700V117KHOLAD	
120	30.1	1800	3.0	3.7	15	57.5 x 80 x 35	52.5	20.3	1.2	MKCHA-700V127KHQLAD	
130	32.2	1950	3.0	3.5	15	57.5 x 65 x 45	52.5	20.3	1.2	MKCHA-700V137KJNLAD	
800 Vdc at 85 °C 950 Vdc at 70 °C 520 Vdc at 105 °C U_{TT} 1200 Vdc/10s	1	2.0	75	63.0	39.5	75	32 x 18 x 9	27.5	\	0.8	MKCHA-800V105KBDGGB
	2	3.4	150	31.5	25.8	75	32 x 20 x 11	27.5	\	0.8	MKCHA-800V205KCEGGB
	3	4.4	225	21.5	23.1	75	32 x 22 x 13	27.5	\	0.8	MKCHA-800V305KCEGGB
	3,3	3.9	165	25.5	24.5	50	32 x 28 x 14	27.5	\	0.8	MKCHA-800V335KCFGGB
	5	5.9	250	12.0	22.7	50	32 x 28 x 14	27.5	\	0.8	MKCHA-800V505KCFGGB
	6	7.4	450	10.5	16.6	75	32 x 28 x 18	27.5	\	0.8	MKCHA-800V605KDFGGB
	8	9.3	176	9.5	11.5	22	32 x 33 x 18	27.5	\	0.8	MKCHA-800V805KDGGGB
	9	9.8	198	8.5	11.6	22	32 x 33 x 18	27.5	\	0.8	MKCHA-800V905KDGGGB
	10	11.3	220	9.5	7.9	22	32 x 37 x 22	27.5	\	0.8	MKCHA-800V106KEHGGB
		7.9	300	12.5	12.3	30	42.5 x 32 x 19	37.5	\	1	MKCHA-800V106KDGIBC
	15	9.9	450	8.0	12.3	30	42.5 x 40 x 20	37.5	10.2	1	MKCHA-800V156KEIAC
	20	11.8	600	7.0	9.8	30	42.5 x 37 x 28	37.5	10.2	1	MKCHA-800V206KFHIAC

MKCHA · PCB mount · 105 °C

Rated DC Voltage U_N derating Voltage test between terminals U_T	Nominal Capacitance C_N [μ F]	Ripple Current at 70°C 1k–10kHz I_r [A RMS]	Peak Current Maximum value \hat{I} [A]	ESR ESR [m Ω]	Thermal Resist. R_{th} [K/W]	dv/dt [V/ μ s]	Dimensions			Product Code	
							Case Size L x H x T [mm]		Terminals		
							P1 [mm]	P2 [mm]	$\varnothing d$ [mm]		
800 Vdc at 85°C 950 Vdc at 70 °C 520 Vdc at 105 °C U_T 1200Vdc/10s	20	13.3	600	6.5	8.3	30	42.5 x 44 x 24	37.5	10.2	1	MKCHA-800V206KEIAC
	22	13.8	660	6.0	8.4	30	42.5 x 44 x 24	37.5	10.2	1	MKCHA-800V226KEIAC
	25	13.8	425	5.5	9.2	17	42.5 x 45 x 30	37.5	20.3	1.2	MKCHA-800V256KGJIAD
	30	15.8	900	4.5	8.6	30	42.5 x 45 x 30	37.5	20.3	1.2	MKCHA-800V306KGJIAD
	35	14.1	420	6.5	7.5	12	57.5 x 45 x 30	52.5	20.3	1.2	MKCHA-800V356KGJLAD
	40	13.9	600	6.0	8.4	15	57.5 x 45 x 30	52.5	20.3	1.2	MKCHA-800V406KGJLAD
	45	15.4	675	5.5	7.6	15	57.5 x 45 x 30	52.5	20.3	1.2	MKCHA-800V456KGJLAD
	47	17.4	564	5.0	6.5	12	57.5 x 50 x 35	52.5	20.3	1.2	MKCHA-800V476KHKLAD
	50	15.9	600	5.0	7.8	12	57.5 x 50 x 35	52.5	20.3	1.2	MKCHA-800V506KHKLAD
	55	17.0	660	4.5	7.5	12	57.5 x 50 x 35	52.5	20.3	1.2	MKCHA-800V556KHKLAD
	65	19.0	780	4.0	6.9	12	57.5 x 60 x 35	52.5	20.3	1.2	MKCHA-800V656KHMLAD
		20.0	975	4.0	6.3	15	57.5 x 55 x 45	52.5	20.3	1.2	MKCHA-800V656KJLLAD
	70	20.1	1050	3.5	6.6	15	57.5 x 55 x 45	52.5	20.3	1.2	MKCHA-800V706KJLLAD
		20.1	1050	3.5	6.6	15	57.5 x 60 x 35	52.5	20.3	1.2	MKCHA-800V706KHMLAD
	75	22.1	1125	3.5	5.4	15	57.5 x 55 x 45	52.5	20.3	1.2	MKCHA-800V756KJLLAD
		22.1	1125	3.5	5.4	15	57.5 x 65 x 35	52.5	20.3	1.2	MKCHA-800V756KHNLAD
	80	23.2	1200	3.5	5.4	15	57.5 x 53 x 50	52.5	20.3	1.2	MKCHA-800V806KKKLAD
		23.2	1200	3.5	5.4	15	57.5 x 70 x 35	52.5	20.3	1.2	MKCHA-800V806KHOLAD
	90	25.3	1350	3.0	4.8	15	57.5 x 53 x 50	52.5	20.3	1.2	MKCHA-800V906KKKLAD
		25.3	1350	3.0	4.8	15	57.5 x 80 x 35	52.5	20.3	1.2	MKCHA-800V906KHQLAD
100	28.4	1500	3.0	4.1	15	57.5 x 65 x 45	52.5	20.3	1.2	MKCHA-800V107KJNLAD	
900 Vdc at 85°C 1070 Vdc at 70 °C 590 Vdc at 105 °C U_T 1350Vdc/10s	1	2.0	60	64.0	38.9	60	32 x 18 x 9	27.5	\	0.8	MKCHA-900V105KBDGGB
	2	2.9	120	25.5	43.5	60	32 x 20 x 11	27.5	\	0.8	MKCHA-900V205KCEGGB
	3	4.9	180	19.0	21.2	60	32 x 22 x 13	27.5	\	0.8	MKCHA-900V305KCEGGB
	3,3	4.9	198	19.0	21.2	60	32 x 24.5 x 15	27.5	\	0.8	MKCHA-900V335KDEGGB
	5	6.9	300	12.5	16.0	60	32 x 28 x 18	27.5	\	0.8	MKCHA-900V505KDFGGB
	6	7.9	360	11.0	13.9	60	32 x 33 x 18	27.5	\	0.8	MKCHA-900V605KDGGB
	8	10.3	480	10.0	8.9	60	32 x 37 x 22	27.5	\	0.8	MKCHA-900V805KEHGGB
	10	11.8	600	10.0	6.8	60	32 x 37 x 22	27.5	\	0.8	MKCHA-900V106KEHGGB
		8.4	350	12.0	11.3	35	42.5 x 40 x 20	37.5	\	1	MKCHA-900V106KEIIBC
	15	9.3	350	11.5	9.4	35	42.5 x 40 x 20	37.5	10.2	1	MKCHA-900V106KEIAC
		10.3	525	8.0	11.1	35	42.5 x 44 x 24	37.5	\	1	MKCHA-900V156KEIIBC
	18	10.4	630	8.0	11.1	35	42.5 x 44 x 24	37.5	\	1	MKCHA-900V186KEIIBC
		11.8	630	7.5	9.2	35	42.5 x 44 x 24	37.5	10.2	1	MKCHA-900V186KEIAC
	20	13.8	700	6.0	8.4	35	42.5 x 45 x 30	37.5	\	1	MKCHA-900V206KGJIBC
		14.8	700	5.5	8.0	35	42.5 x 45 x 30	37.5	20.3	1.2	MKCHA-900V206KGJIAD
	25	16.8	875	5.5	6.2	35	42.5 x 45 x 30	37.5	20.3	1.2	MKCHA-900V256KGJIAD
	30	18.8	1050	5.0	5.4	35	42.5 x 50 x 35	37.5	20.3	1.2	MKCHA-900V306KHKIAD
		14.9	450	5.5	8.0	15	57.5 x 45 x 30	52.5	20.3	1.2	MKCHA-900V306KGJLAD
	35	15.4	525	5.5	7.5	15	57.5 x 50 x 35	52.5	20.3	1.2	MKCHA-900V356KHKLAD
	40	15.9	600	6.5	6.0	15	57.5 x 50 x 35	52.5	20.3	1.2	MKCHA-900V406KHKLAD
	50	17.9	750	3.5	8.6	15	57.5 x 50 x 35	52.5	20.3	1.2	MKCHA-900V506KHKLAD
	55	19.0	825	3.5	7.9	15	57.5 x 60 x 35	52.5	20.3	1.2	MKCHA-900V556KHMLAD
		20.0	825	3.5	7.4	15	57.5 x 55 x 45	52.5	20.3	1.2	MKCHA-900V556KJLLAD
	60	20.0	900	3.5	7.4	15	57.5 x 55 x 45	52.5	20.3	1.2	MKCHA-900V606KJLLAD
		20.0	900	3.5	7.4	15	57.5 x 65 x 35	52.5	20.3	1.2	MKCHA-900V606KHNLAD
	65	22.0	975	3.0	6.3	15	57.5 x 70 x 35	52.5	20.3	1.2	MKCHA-900V656KHOLAD
	70	24.1	1050	3.0	5.4	15	57.5 x 53 x 50	52.5	20.3	1.2	MKCHA-900V706KKKLAD
		24.1	1050	3.0	5.4	15	57.5 x 80 x 35	52.5	20.3	1.2	MKCHA-900V706KHQLAD
80	25.2	1200	3.0	5.0	15	57.5 x 65 x 45	52.5	20.3	1.2	MKCHA-900V806KJNLAD	

Rated DC Voltage U_N derating Voltage test between terminals U_T	Nominal Capacitance C_N [μ F]	Ripple Current at 70°C 1k–10kHz I_r [A RMS]	Peak Current Maximum value \uparrow [A]	ESR ESR [m Ω]	Thermal Resist. R_{th} [K/W]	dv/dt [V/ μ s]	Dimensions			Product Code		
							Case Size		Terminals			
							L x H x T [mm]	P1 [mm]	P2 [mm]		$\varnothing d$ [mm]	
1000 Vdc at 85°C 1200 Vdc at 70 °C 650 Vdc at 105 °C U_T 1500 Vdc/10s	1	2.5	70	46.0	34.9	70	32 x 20 x 11	27.5	\	0.8	MKCHA-1000V105KCEGGB	
	2	3.4	120	30.5	26.7	60	32 x 22 x 13	27.5	\	0.8	MKCHA-1000V205KCEGGB	
	3	4.9	180	25.5	15.7	60	32 x 24.5 x 15	27.5	\	0.8	MKCHA-1000V305KDEGGB	
	5	7.9	300	14.0	11.0	60	32 x 33 x 18	27.5	\	0.8	MKCHA-1000V505KDGGB	
	8	9.8	480	12.0	8.2	60	32 x 37 x 22	27.5	\	0.8	MKCHA-1000V805KEHGGB	
	10	8.4	350	12.0	11.3	35	42.5 x 40 x 20	37.5	\	1	MKCHA-1000V106KEIIBC	
		9.3	350	11.5	9.5	35	42.5 x 40 x 20	37.5	10.2	1	MKCHA-1000V106KEIIAC	
	12	10.3	420	9.0	10.0	35	42.5 x 44 x 24	37.5	10.2	1	MKCHA-1000V126KEIIAC	
		10.4	525	8.0	11.2	35	42.5 x 44 x 24	37.5	\	1	MKCHA-1000V156KEIIBC	
	15	11.8	525	7.5	9.2	35	42.5 x 44 x 24	37.5	10.2	1	MKCHA-1000V156KEIIAC	
		13.8	525	7.5	6.7	35	42.5 x 45 x 30	37.5	20.3	1.2	MKCHA-1000V156KGJIAD	
	20	14.8	700	6.5	6.7	35	42.5 x 45 x 30	37.5	20.3	1.2	MKCHA-1000V206KGJIAD	
	25	17.8	875	5.5	5.6	35	42.5 x 50 x 35	37.5	20.3	1.2	MKCHA-1000V256KHKIAD	
	30	14.9	450	5.5	8.1	15	57.5 x 45 x 30	52.5	20.3	1.2	MKCHA-1000V306KJLAD	
	35	15.9	525	5.5	7.1	15	57.5 x 50 x 35	52.5	20.3	1.2	MKCHA-1000V356KHKLAD	
	40	15.9	600	5.0	7.8	15	57.5 x 50 x 35	52.5	20.3	1.2	MKCHA-1000V406KHKLAD	
		16.9	600	5.0	6.9	15	57.5 x 60 x 35	52.5	20.3	1.2	MKCHA-1000V406KHMMLAD	
	50	19.0	750	4.5	6.2	15	57.5 x 55 x 45	52.5	20.3	1.2	MKCHA-1000V506KJLLAD	
		19.0	750	4.5	6.2	15	57.5 x 65 x 35	52.5	20.3	1.2	MKCHA-1000V506KHNMLAD	
	55	20.0	825	4.0	5.7	15	57.5 x 70 x 35	52.5	20.3	1.2	MKCHA-1000V556KHOLAD	
22.1		900	4.0	5.3	15	57.5 x 53 x 50	52.5	20.3	1.2	MKCHA-1000V606KKKLAD		
60	22.1	900	4.0	5.3	15	57.5 x 80 x 35	52.5	20.3	1.2	MKCHA-1000V606KHLAD		
	22.1	900	4.0	5.3	15	57.5 x 65 x 45	52.5	20.3	1.2	MKCHA-1000V606KJNLAD		
1100 Vdc at 85°C 1320 Vdc at 70 °C 720 Vdc at 105 °C U_T 1650 Vdc/10s	1	2.5	70	46.0	34.9	70	32 x 20 x 11	27.5	\	0.8	MKCHA-1100V105KCEGGB	
	1,5	3.4	105	30.5	26.7	70	32 x 22 x 13	27.5	\	0.8	MKCHA-1100V155KCEGGB	
	2	3.9	140	25.5	24.5	70	32 x 24.5 x 15	27.5	\	0.8	MKCHA-1100V205KDEGGB	
	2,2	4.9	154	17.0	23.8	70	32 x 28 x 14	27.5	\	0.8	MKCHA-1100V225KCFGGB	
	3,3	6.4	231	11.5	20.2	70	32 x 28 x 18	27.5	\	0.8	MKCHA-1100V335KDFGGB	
	4	7.9	280	10.5	14.6	70	32 x 33 x 18	27.5	\	0.8	MKCHA-1100V405KDGGB	
	5	8.4	350	9.5	14.4	70	32 x 37 x 22	27.5	\	0.8	MKCHA-1100V505KEHGGB	
	6,8	11.8	272	13.5	5.0	40	42.5 x 33.5 x 22	37.5	10.2	1	MKCHA-1100V685KEGIAC	
		10.3	320	14.0	6.4	40	42.5 x 40 x 20	37.5	\	1	MKCHA-1100V805KEIIBC	
	8	12.3	320	12.5	5.0	40	42.5 x 40 x 20	37.5	10.2	1	MKCHA-1100V805KEIIAC	
		12.3	320	12.5	5.0	40	42.5 x 37 x 22	37.5	10.2	1	MKCHA-1100V805KEHIAC	
	9	12.6	360	12.5	4.9	40	42.5 x 37 x 22	37.5	10.2	1	MKCHA-1100V905KEHIAC	
	10	13.8	400	9.0	5.6	40	42.5 x 44 x 24	37.5	\	1	MKCHA-1100V106KEIIBC	
		14.8	400	8.5	5.1	40	42.5 x 44 x 24	37.5	10.2	1	MKCHA-1100V106KEIIAC	
	12	15.3	480	7.5	5.4	40	42.5 x 45 x 30	37.5	20.3	1.2	MKCHA-1100V126KGJIAD	
	15	15.8	600	7.0	5.5	40	42.5 x 45 x 30	37.5	20.3	1.2	MKCHA-1100V156KGJIAD	
	18	15.4	720	7.5	5.5	40	42.5 x 50 x 35	37.5	20.3	1.2	MKCHA-1100V186KHKIAD	
	20	16.4	400	7.0	5.1	20	42.5 x 50 x 35	37.5	20.3	1.2	MKCHA-1100V206KHKIAD	
		11.9	400	8.5	8.1	20	57.5 x 45 x 30	52.5	20.3	1.2	MKCHA-1100V206KJLAD	
	25	13.0	500	8.0	7.2	20	57.5 x 50 x 35	52.5	20.3	1.2	MKCHA-1100V256KHKLAD	
	30	15.0	600	5.0	8.9	20	57.5 x 50 x 35	52.5	20.3	1.2	MKCHA-1100V306KHKLAD	
	35	16.1	700	5.0	8.0	20	57.5 x 60 x 35	52.5	20.3	1.2	MKCHA-1100V356KHMMLAD	
	40	17.1	800	5.5	6.3	20	57.5 x 65 x 35	52.5	20.3	1.2	MKCHA-1100V406KHNMLAD	
		17.1	800	5.5	6.3	20	57.5 x 55 x 45	52.5	20.3	1.2	MKCHA-1100V406KJLLAD	
	45	18.2	900	5.5	5.8	20	57.5 x 70 x 35	52.5	20.3	1.2	MKCHA-1100V456KHOLAD	
	50	19.8	1000	5.0	5.2	20	57.5 x 65 x 45	52.5	20.3	1.2	MKCHA-1100V506KJNLAD	
		20.3	1000	4.5	5.7	20	57.5 x 53 x 50	52.5	20.3	1.2	MKCHA-1100V506KKKLAD	

Rated DC Voltage U_N derating Voltage test between terminals U_{TT}	Nominal Capacitance C_N [μ F]	Ripple Current at 70°C 1 k–10 kHz I_r [A RMS]	Peak Current Maximum value \hat{I} [A]	ESR ESR [m Ω]	Thermal Resist. R_{th} [K/W]	dv/dt [V/ μ s]	Dimensions			Product Code	
							Case Size L x H x T [mm]	Terminals P1 [mm]	P2 [mm]		$\varnothing d$ [mm]
1200 Vdc at 85°C 1440 Vdc at 70 °C 780 Vdc at 105 °C U_{TT} 1800 Vdc/10s	1	4.4	80	33.0	14.9	80	32 x 20 x 11	27.5	\	0.8	MKCHA-1200V105KCEGGB
	2	4.9	160	33.0	12.1	80	32 x 24.5 x 15	27.5	\	0.8	MKCHA-1200V205KDEGGB
	2,2	5.4	176	17.5	19.0	80	32 x 28 x 18	27.5	\	0.8	MKCHA-1200V225KDFGGB
	3	6.9	240	16.5	12.6	80	32 x 28 x 18	27.5	\	0.8	MKCHA-1200V305KDFGGB
	3,3	7.9	264	13.5	11.4	80	32 x 33 x 18	27.5	\	0.8	MKCHA-1200V335KDGGBB
	5	9.8	400	12.0	8.2	80	32 x 37 x 22	27.5	\	0.8	MKCHA-1200V505KEHGGB
		7.4	225	15.5	11.3	45	42.5 x 33.5 x 22	37.5	\	1	MKCHA-1200V505KEGIBC
	6	7.4	270	15.5	11.3	45	42.5 x 40 x 20	37.5	\	1	MKCHA-1200V605KEIIBC
	7	7.9	315	15.5	10.1	45	42.5 x 37 x 22	37.5	10.2	1	MKCHA-1200V705KEHIAC
	8	8.9	360	12.5	9.8	45	42.5 x 44 x 24	37.5	10.2	1	MKCHA-1200V805KEIIAC
	10	9.9	450	10.5	9.4	45	42.5 x 44 x 24	37.5	10.2	1	MKCHA-1200V106KEIIAC
		11.8	450	8.0	8.6	45	42.5 x 45 x 30	37.5	20.3	1.2	MKCHA-1200V106KGJIAD
	15	14.9	675	6.5	6.7	45	42.5 x 50 x 35	37.5	20.3	1.2	MKCHA-1200V156KHKIAD
	20	12.9	500	8.5	7.0	25	57.5 x 45 x 30	52.5	20.3	1.2	MKCHA-1200V206KJLAD
		15.0	625	6.5	6.8	25	57.5 x 50 x 35	52.5	20.3	1.2	MKCHA-1200V256KHKLAD
	30	17.0	750	5.5	6.3	25	57.5 x 55 x 45	52.5	20.3	1.2	MKCHA-1200V306KJLLAD
		17.0	750	5.5	6.3	25	57.5 x 60 x 35	52.5	20.3	1.2	MKCHA-1200V306KHMLAD
	35	18.1	875	5.0	6.2	25	57.5 x 55 x 45	52.5	20.3	1.2	MKCHA-1200V356KJLLAD
		18.1	875	5.0	6.2	25	57.5 x 70 x 35	52.5	20.3	1.2	MKCHA-1200V356KHOLAD
	40	20.1	1000	4.5	5.6	25	57.5 x 53 x 50	52.5	20.3	1.2	MKCHA-1200V406KKKLAD
45	22.2	1125	4.0	4.8	25	57.5 x 65 x 45	52.5	20.3	1.2	MKCHA-1200V456KJNLAD	
1500 Vdc at 85°C 1800 Vdc at 70 °C 980 Vdc at 105 °C U_{TT} 2250 Vdc/10s	6,5	11.8	293	10.5	6.5	45	42 x 42 x 28	37.5	10.3	1	MKCHA-1500V655KFIAC
	11	19.6	71	6.5	3.7	30	42 x 50 x 35	37.5	20.3	1.2	MKCHA-1500V116KHKIAD

Additional designs on request · Weitere Designs auf Anfrage

> Soldering Parameters · Lötparameter

- Manual with soldering iron · LötKolben: **Max. 350°C/3s**
- Wave soldering · Wellenlöten: **Max. 260°C/4s or 250°C/6s**

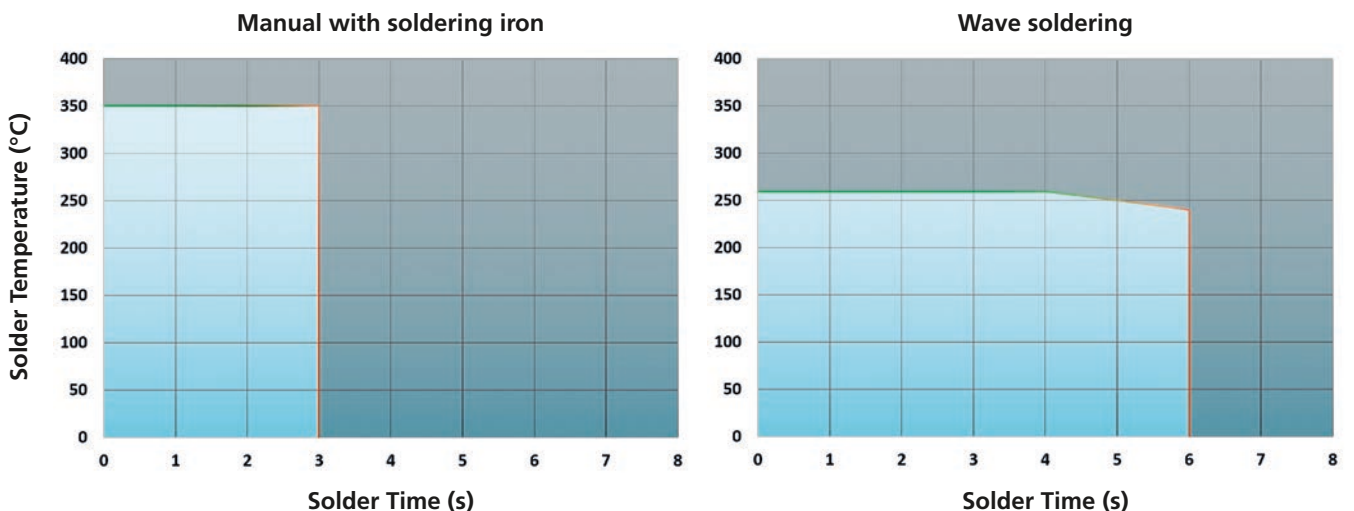

> Life Time Table · Brauchbarkeitsdauer – Tabelle

Lifetime as function of ratio between the effective working voltage U_w and the rated DC voltage U_N													
$T_{HOTSPOT}$	x 0.5	x 0.6	x 0.7	x 0.75	x 0.8	x 0.85	x 0.9	x 0.95	x 1.0	x 1.05	x 1.1	x 1.15	x 1.20
50 °C	250	250	250	250	250	250	250	250	250	250	181	116	76
60 °C	250	250	250	250	250	250	250	250	234	144	91	58	38
70 °C	250	250	250	250	250	250	250	196	117	72	45	29	19
75 °C	250	250	250	250	250	250	238	138	83	51	32	21	
80 °C	250	250	250	250	250	250	168	98	59	36	23		
85 °C	250	250	250	250	250	210	119	69	42				
90 °C	250	250	250	228	132	79	48	30					
95 °C	250	250	114	70	45	30							
100 °C	200	75	32	22	16								
105 °C	34	17	9										

khrs value limited to 250 000 hours.

> Life Time Graph · Brauchbarkeitsdauer – Diagramm

Lifetime expectancy depending on hotspot temperature $T_{HOTSPOT}$ versus ratio between the effective working voltage U_w and the rated DC voltage U_N

Lebenserwartung in Abhängigkeit von der hotspot Temperatur $T_{HOTSPOT}$ und dem Verhältnis der tatsächlich anliegenden Spannung zur DC Nennspannung U_N

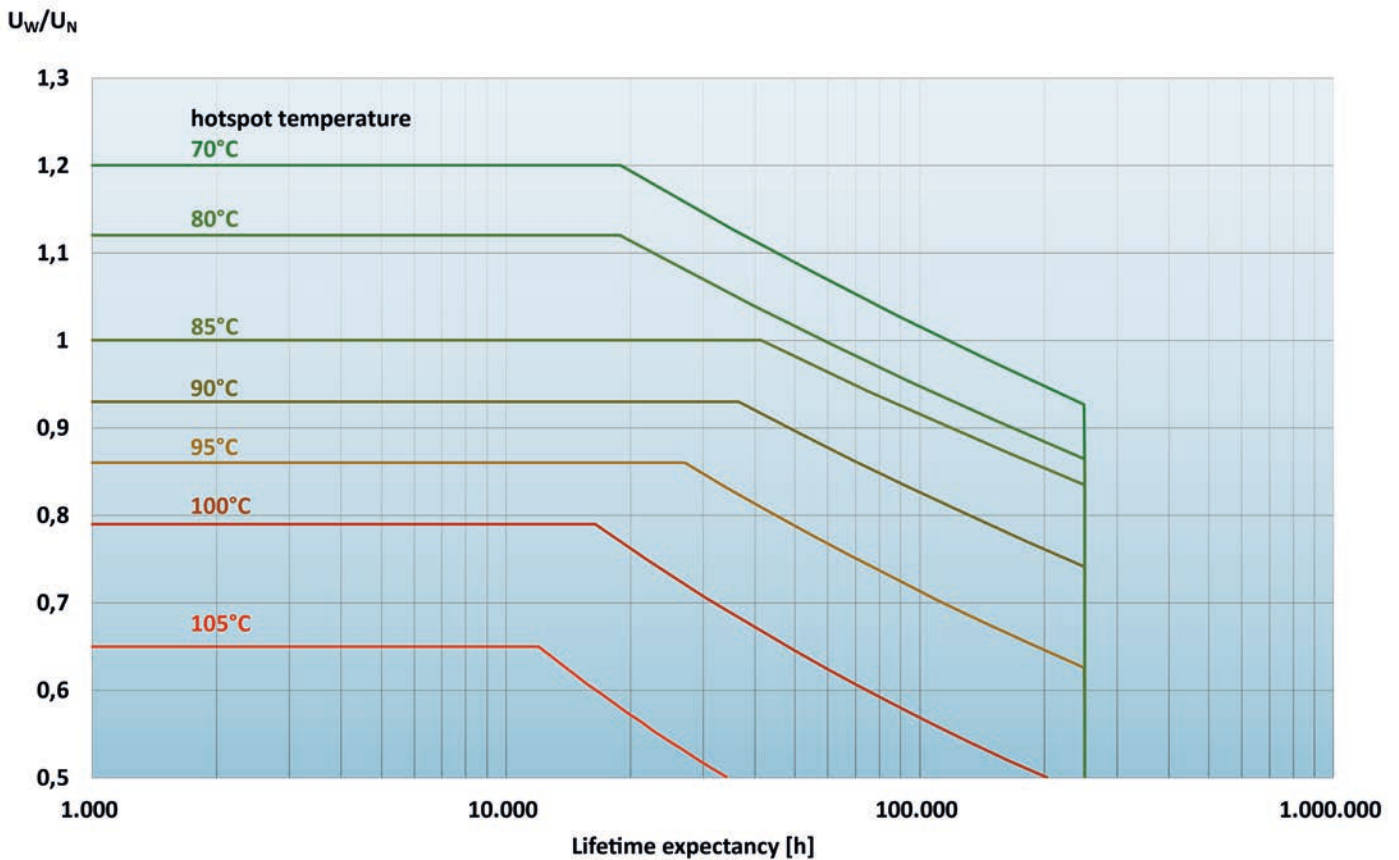

$$T_{HOTSPOT} = T_a + I^2 \times ESR \times R_{th}$$

MKCP4 · MKCP4T · PCB mount · 105 °C

Resin-encased box type · optional Fuse Function for high withstanding voltage
 MKCP4T High-Humidity THB-type · 85 °C · 85 % RH · 1000 hrs

> Specifications · Spezifikationen

Items	Characteristics
Temperature range	-40 °C ~ +105 °C voltage derating when hotspot temp \geq 85 °C
Rated Voltage U_N	450, 700, 900, 1100 Vdc at 85 °C further rated voltage on request
Voltage test between terminals U_{TT}	$1.5 \times U_N / 10$ s
Maximum ripple Voltage U_{AC} peak to peak	$0.2 \times U_N$ 85 °C
Terminals	tinned wired leads
Life Time Test / Standard	IEC 61071:2007
Life Time Expectancy	170 000 hrs ($T_{HOTSPOT}$ 75 °C, $1.0 \times U_N$)
Failure Rate	$<= 0.5$ FIT = 0.5×10^{-9} Failures / hour
Dielectric	Polypropylene
Safety function	Self healing film – optional segmented film with fuse function
Case material	PBT conform to UL94V-0
Filling material	resin conform to UL94V-0
Product Compliance	RoHS, REACH, Conflict Minerals a.o. - refer to p.12–13



> Dimensions · Abmessungen

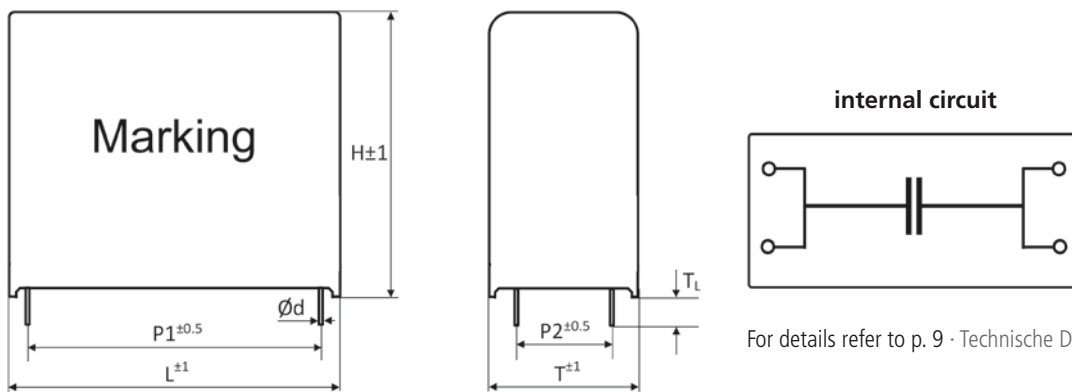

For details refer to p. 9 · Technische Details siehe S. 9

> Voltage and current derating vs. temperature · Spannung und Strom Abstufung

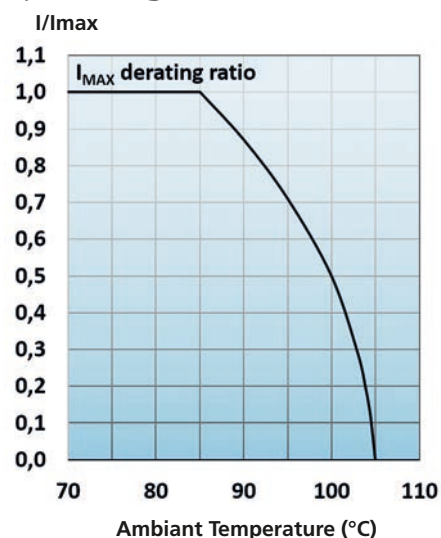
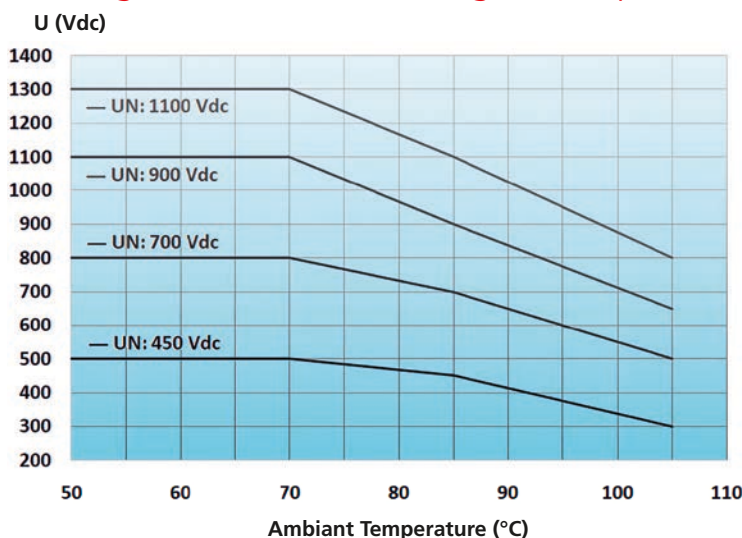

> Case Code · Gehäuse Codierung

Example: MKCP4 700Vdc · 60 µF · T=35.0 mm, H=50.0 mm, L=57.5 mm
 Product Code MKCP4-700V606KHKL

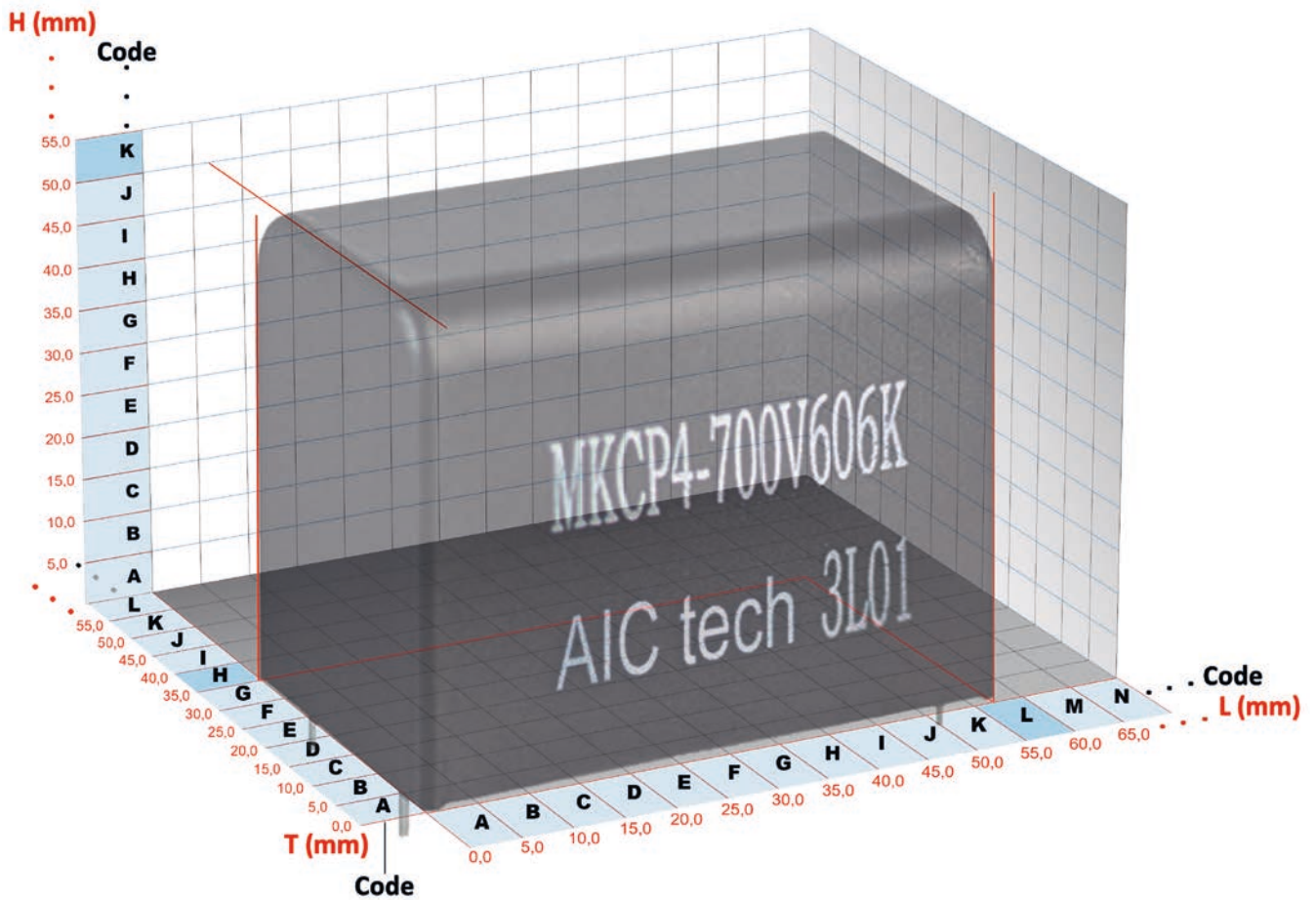

Case dimension code	Case (mm)			Terminals (mm)		
	T	H	L	P1	P2	Ød
DGI	16.0	31.0	41.0	37.5	5.0	1.0
	18.0	32.0	42.0	37.5	10.2	1.0
ECG	20.0	14.0	31.5	27.5	5.0	1.0
EHI	21.5	38.5	43.0	37.5	10.2	1.0
EGI	23.0	34.0	43.0	37.5	10.2	1.2
EII	24.0	44.0	42.0	37.5	10.2	1.0
FJL	25.0	45.0	57.5	52.5	10.2	1.2
FEI	27.0	21.0	42.0	37.5	10.2	1.2
FHI	27.0	36.0	41.0	37.5	10.2	1.2
FII	28.0	42.5	42.0	37.5	10.2	1.0
	29.0	44.0	41.0	37.5	15.0	1.2
GJI	30.0	45.0	42.0	37.5	20.3	1.0
GJL	30.0	45.0	57.5	52.5	20.3	1.2
GLI	30.0	55.0	42.0	37.5	20.3	1.0

Case dimension code	Case (mm)			Terminals (mm)		
	T	H	L	P1	P2	Ød
HEL	35.0	24.0	57.5	52.5	20.3	1.2
HKL	35.0	50.0	57.5	52.5	20.3	1.2
HML	35.0	60.0	57.5	52.5	20.3	1.2
HNL	35.0	65.0	57.5	52.5	20.3	1.2
HQL	35.0	80.0	57.5	52.5	20.3	1.2
HEL	39.0	24.0	57.5	52.5	20.3	1.2
IEL	43.0	22.0	57.5	52.5	20.3	1.2
JEI	45.0	21.0	42.0	37.5	20.3	1.2
JLL	45.0	57.0	57.5	52.5	20.3	1.2
JNL	45.0	65.0	57.5	52.5	20.3	1.2
MJL	60.0	45.0	57.5	52.5	20.3	1.2

Additional designs on request · Weitere Designs auf Anfrage

> Product Code · Bestellbezeichnung

Example: Series MKCP4 · 900V · 60µF +/- 10% · T=60 mm · H=45 mm · L = 57.5 mm

MKCP4	900V	606	K	MJL	
Type of series	Rated voltage xxxV	Capacitance code	Capacitance tolerance	Case Code	Specific features (...)
		The first two digits are significant. The last digit indicates the number of following zeros in pF.	K : ± 10% J : ± 5%		

Rated DC Voltage U_N derating Voltage test between terminals U_T	Nominal Capacitance C_N [µF]	Ripple Current at 85 °C 1 k–10 kHz I_r^* [A RMS]	Peak Current Maximum value \hat{I} [A]	ESR [mΩ]	ESL [nH]	Thermal Resist. R_{th} [K/W]	dv/dt [V/µs]	Dimensions			Product Code	
								Case Size $T \times H \times L$ [mm]	Terminals $P1$ [mm] $P2$ [mm] $\varnothing d$ [mm]			
450 Vdc at 85°C 500Vdc at 70 °C 300Vdc at 105 °C U_T 650Vdc / 10s	20	12.0	800	6.0	18	13.0	40	21.5x38.5x43	37.5	10.2	1.0	MKCP4-450V206KEHI
		12.5	800	6.0	19	12.0	40	24x44x42	37.5	10.2	1.0	MKCP4-450V206KEII
	25	13.0	1000	5.5	19	12.0	40	24x44x42	37.5	10.2	1.0	MKCP4-450V256KEII
		12.0	800	6.0	18	13.0	40	21.5x38.5x43	37.5	10.2	1.0	MKCP4-450V306KEHI
	30	17.0	1200	3.5	19	12.0	40	24x44x42	37.5	10.2	1.0	MKCP4-450V306KEIIR
		14.0	900	5.0	19	12.0	40	24x44x42	37.5	10.2	1.0	MKCP4-450V356KEII
	35	18.5	1400	3.5	19	9.5	40	30x45x42	37.5	20.3	1.0	MKCP4-450V356KGJI
		18.5	1400	3.5	19	9.5	40	30x45x42	37.5	20.3	1.0	MKCP4-450V406KGJI
	40	18.5	1600	3.5	21	9.5	40	30x55x42	37.5	20.3	1.0	MKCP4-450V406KGLI
		13.5	800	6.0	19	11.0	20	25x45x57.5	52.5	10.2	1.2	MKCP4-450V406KFJL
	45	13.5	900	6.0	19	11.0	20	25x45x57.5	52.5	10.2	1.2	MKCP4-450V456KFJL
		20.5	1400	3.0	21	9.5	40	30x55x42	37.5	20.3	1.0	MKCP4-450V456KGLI
	50	15.5	1000	5.0	19	9.5	20	30x45x57.5	52.5	20.3	1.2	MKCP4-450V506KGJL
	55	20.5	1300	4.0	21	8.0	20	35x50x57.5	52.5	20.3	1.2	MKCP4-450V556KHKL
	60	18.0	1200	4.5	20	8.0	20	35x50x57.5	52.5	20.3	1.2	MKCP4-450V606KHKL
	65	20.5	1300	4.0	21	8.0	20	35x50x57.5	52.5	20.3	1.2	MKCP4-450V656KHKL
	70	19.0	1400	4.0	20	8.0	20	35x50x57.5	52.5	20.3	1.2	MKCP4-450V706KHKL
	80	20.5	1600	3.5	21	8.0	20	35x50x57.5	52.5	20.3	1.2	MKCP4-450V806KHKL
85	20.5	1700	3.5	21	8.0	20	35x60x57.5	52.5	20.3	1.2	MKCP4-450V856KHML	
90	22.0	1800	3.0	21	8.0	20	35x60x57.5	52.5	20.3	1.2	MKCP4-450V906KHML	
180	22.0	2500	3.0	28	8.0	14	35x80x57.5	52.5	20.3	1.2	MKCP4-450V187KHQLP	
700 Vdc at 85°C 800Vdc at 70 °C 500Vdc at 105 °C U_T 1050Vdc / 10s	10	8.0	400	12.0	17	15.5	40	18x32x42	37.5	10.2	1.0	MKCP4-700V106KDGI
	20	12.0	800	6.0	18	13.0	40	21.5x38.5x43	37.5	10.2	1.0	MKCP4-700V206KEHI
	22	13.5	880	5.5	19	12.0	40	24x44x42	37.5	10.2	1.0	MKCP4-700V226KEII
	25	14.0	1000	5.5	30	11.0	40	28x42.5x42	37.5	10.2	1.0	MKCP4-700V256KFII
		17.0	1200	4.0	19	9.5	40	30x45x42	37.5	20.3	1.0	MKCP4-700V306KGJI
	30	12.0	600	8.0	19	11.0	20	25x45x57.5	52.5	10.2	1.2	MKCP4-700V306KFJL
		18.5	1400	3.5	19	9.5	40	30x45x42	37.5	20.3	1.2	MKCP4-700V356KGJIS
	35	12.5	700	7.0	19	11.0	20	25x45x57.5	52.5	10.2	1.2	MKCP4-700V356KFJL
		13.5	800	6.0	19	11.0	20	25x45x57.5	52.5	10.2	1.2	MKCP4-700V406KFJL
	45	15.0	900	5.5	19	9.5	20	30x45x57.5	52.5	20.3	1.2	MKCP4-700V456KGJL
	50	17.3	1000	4.0	22	11.0	20	25x65x57.5	52.5	10.2	1.2	MKCP4-700V506KFNLR
		14.2	1000	5.5	20	9.5	20	30x45x57.5	52.5	20.3	1.2	MKCP4-700V506KGJL

* additional information for I_r on page 54 and 61

Additional designs on request · Weitere Designs auf Anfrage

Rated DC Voltage U_N derating Voltage test between terminals U_{TT}	Nominal Capacitance C_N [μ F]	Ripple Current at 85 °C 1 k–10 kHz I_r^* [A RMS]	Peak Current Maximum value \hat{I} [A]	ESR ESR [m Ω]	ESL ESL [nH]	Thermal Resist. R_{th} [K/W]	dv/dt [V/ μ s]	Dimensions				Product Code
								Case Size		Terminals		
								T x H x L [mm]	P1 [mm]	P2 [mm]	$\varnothing d$ [mm]	
700 Vdc at 85 °C 800Vdc at 70 °C 500Vdc at 105 °C U_{TT} 1050Vdc/10s	55	18.0	1100	4.5	20	8.0	20	35x50x57.5	52.5	20.3	1.2	MKCP4-700V556KHKL
	60	19.0	1200	4.0	20	8.0	20	35x50x57.5	52.5	20.3	1.2	MKCP4-700V606KHKL
	65	20.5	1300	3.5	20	8.0	20	35x50x57.5	52.5	20.3	1.2	MKCP4-700V656KHKL
	70	20.5	1400	3.5	21	8.0	20	35x60x57.5	52.5	20.3	1.2	MKCP4-700V706KHML
	80	21.5	1600	3.0	21	8.0	20	35x60x57.5	52.5	20.3	1.2	MKCP4-700V806KHML
	85	22.0	1700	3.0	22	8.0	20	35x65x57.5	52.5	20.3	1.2	MKCP4-700V856KHNL
	90	22.0	1800	3.0	22	8.0	20	35x65x57.5	52.5	20.3	1.2	MKCP4-700V906KHNL
		23.0	1800	3.0	21	7.5	20	45x57x57.5	52.5	20.3	1.2	MKCP4-700V906KJLL
	100	24.0	2000	2.5	28	8.0	20	35x80x57.5	52.5	20.3	1.2	MKCP4-700V107KHQL
		25.0	2000	2.5	22	7.5	20	45x65x57.5	52.5	20.3	1.2	MKCP4-700V107KJNL
25.0		2000	2.5	19	6.0	20	60x45x57.5	52.5	20.3	1.2	MKCP4-700V107KMJL	
120	22.0	2400	3.0	28	8.0	20	35x80x57.5	52.5	20.3	1.2	MKCP4-700V127KHQLP	
900 Vdc at 85 °C 1100Vdc at 70 °C 650Vdc at 105 °C U_{TT} 1350Vdc/10s	2.5	4.0	150	35.0	14	20.0	60	20x14x31.5	27.5	5.0	1.0	MKCP4-900V255KECGAS
	5	8.0	200	22.0	18	13.0	40	27x21x42	37.5	10.2	1.2	MKCP4-900V505KFEI
	5.5	11.0	220	9.5	18	12.0	40	23x34x43	37.5	10.2	1.2	MKCP4-900V555KEGIS
	8	7.0	230	16.5	18	15.5	40	16x31x41	37.5	5.0	1.0	MKCP4-900V805KDGIAS
	10	9.0	400	11.0	18	13.0	40	21.5x38.5x43	37.5	10.2	1.0	MKCP4-900V106KEHI
		10.0	480	9.0	18	13.0	40	21.5x38.5x43	37.5	10.2	1.0	MKCP4-900V126KEHI
	12	10.0	240	15.0	18	8.0	20	35x24x57.5	52.5	20.3	1.2	MKCP4-900V126KHEL
		10.0	520	9.0	18	13.0	40	45x21x42	37.5	20.3	1.2	MKCP4-900V136KJEI
	13	12.0	600	7.0	19	12.0	40	24x44x42	37.5	10.2	1.0	MKCP4-900V156KEII
		9.5	300	12.0	19	11.0	20	25x45x57.5	52.5	10.2	1.2	MKCP4-900V156KFJL
		12.0	400	8.0	18	10.5	40	27x36x41	37.5	15.0	1.2	MKCP4-900V156KFHIDS
	16	11.5	400	11.5	18	8.0	20	39x24x57.5	52.5	20.3	1.2	MKCP4-900V166KHEL
	17	8.6	340	12.0	19	8.0	20	43x22x57.5	52.5	20.3	1.2	MKCP4-900V176KIELS
	20	15.5	800	5.0	19	9.5	40	30x45x42	37.5	20.3	1.0	MKCP4-900V206KGJI
		10.0	400	11.0	19	11.0	20	25x45x57.5	52.5	10.2	1.2	MKCP4-900V206KFJL
	25	15.5	700	5.0	19	9.5	40	29x44x41	37.5	15.0	1.2	MKCP4-900V206KFIAS
		11.5	500	9.0	19	9.5	20	30x45x57.5	52.5	20.3	1.2	MKCP4-900V256KGJL
	35	15.5	700	6.0	20	8.0	20	35x50x57.5	52.5	20.3	1.2	MKCP4-900V356KHKL
	40	17.0	800	5.0	20	8.0	20	35x50x57.5	52.5	20.3	1.2	MKCP4-900V406KHKL
	45	16.5	900	5.0	21	8.0	20	35x60x57.5	52.5	20.3	1.2	MKCP4-900V456KHML
	50	18.5	1000	4.0	21	8.0	20	35x60x57.5	52.5	20.3	1.2	MKCP4-900V506KHML
		19.0	1100	4.0	22	8.0	20	35x65x57.5	52.5	20.3	1.2	MKCP4-900V556KHNL
	55	19.6	1100	4.0	21	7.5	20	45x57x57.5	52.5	20.3	1.2	MKCP4-900V556KJLL
		23.5	1200	3.5	19	6.0	20	60x45x57.5	52.5	20.3	1.2	MKCP4-900V606KMJL
		20.5	1200	3.5	28	8.0	20	35x80x57.5	52.5	20.3	1.2	MKCP4-900V606KHQL
	60	23.0	1300	3.0	22	7.5	20	45x65x57.5	52.5	20.3	1.2	MKCP4-900V656KJNL

* additional information for I_r on page 54 and 61

Additional designs on request · Weitere Designs auf Anfrage

MKCP4 · PCB mount · 105 °C

Rated DC Voltage U_N derating Voltage test between terminals U_T	Nominal Capacitance C_N [μ F]	Ripple Current at 85 °C 1 k–10 kHz I_r^* [A RMS]	Peak Current Maximum value \hat{I} [A]	ESR [m Ω]	ESL [nH]	Thermal Resist. R_{th} [K/W]	dv/dt [V/ μ s]	Dimensions				Product Code	
								Case Size		Terminals			
								T x H x L [mm]	P1 [mm]	P2 [mm]	$\varnothing d$ [mm]		
1100 Vdc at 85 °C 1300Vdc at 70 °C 800Vdc at 105 °C U_T 1650Vdc/10s	4	5.5	180	27.0	18	15.5	45	18x32x42	37.5	10.2	1.0	MKCP4-1100V405KDGI	
	5	7.5	225	16.0	18	13.0	45	21.5x38.5x43	37.5	10.2	1.0	MKCP4-1100V505KEHI	
	7	8.5	310	11.5	18	13.0	45	21.5x38.5x43	37.5	10.2	1.0	MKCP4-1100V705KEHI	
	8	9.5	360	10.0	18	13.0	45	21.5x38.5x43	37.5	10.2	1.0	MKCP4-1100V805KEHI	
	10	11.0	459	8.0	19	10.5	45	24x44x42	37.5	10.2	1.0	MKCP4-1100V106KEII	
		8.5	230	16.0	19	11.0	23	25x45x57.5	52.5	10.2	1.2	MKCP4-1100V106KFJL	
	12	13.5	540	6.5	19	9.5	45	30x45x42	37.5	20.3	1.0	MKCP4-1100V126KGJI	
	15	10.5	340	10.5	19	11.0	23	25x45x57.5	52.5	10.2	1.2	MKCP4-1100V156KFJL	
		15.0	670	5.5	21	9.5	45	30x55x42	37.5	20.3	1.0	MKCP4-1100V156KGLI	
	20	12.5	460	8.0	19	9.5	23	30x45x57.5	52.5	20.3	1.2	MKCP4-1100V206KGJL	
	22	14.5	500	7.0	20	8.0	23	35x50x57.5	52.5	20.3	1.2	MKCP4-1100V226KHKL	
	25	15.0	550	6.5	20	8.0	23	35x50x57.5	52.5	20.3	1.2	MKCP4-1100V256KHKL	
	30	16.5	690	5.0	21	8.0	23	35x60x57.5	52.5	20.3	1.2	MKCP4-1100V306KHML	
	35	18.0	800	4.5	22	8.0	23	35x65x57.5	52.5	20.3	1.2	MKCP4-1100V356KHNL	
		18.0	800	4.5	21	7.5	23	45x57x57.5	52.5	20.3	1.2	MKCP4-1100V356KJLL	
	40	22.0	920	4.0	19	6.0	23	60x45x57.5	52.5	20.3	1.2	MKCP4-1100V406KMJL	
		19.0	920	4.0	29	8.0	23	35x80x57.5	52.5	20.3	1.2	MKCP4-1100V406KHQL	
	45	19.5	1000	4.0	22	7.5	23	45x65x57.5	52.5	20.3	1.2	MKCP4-1100V456KJNL	

* additional information for I_r on page 54 and 61

Additional designs on request · Weitere Designs auf Anfrage

Rated DC Voltage U_N derating Voltage test between terminals U_{TT}	Nominal Capacitance C_N [μ F]	Ripple Current at 85 °C 1 k–10 kHz I_r^* [A RMS]	Peak Current Maximum value \hat{I} [A]	ESR	ESL	Thermal Resist. R_{th} [K/W]	dv/dt [V/ μ s]	Dimensions				Product Code
								Case Size		Terminals		
								T x H x L [mm]	P1 [mm]	P2 [mm]	$\varnothing d$ [mm]	
450 Vdc at 85 °C 500Vdc at 70 °C 300Vdc at 105 °C U_{TT} 650Vdc/10s	20	12.0	800	6.0	18	13.0	40	21.5x38.5x43	37.5	10.2	1.0	MKCP4T-450V206KEHI
	25	13.0	1000	5.5	19	12.0	40	24x44x42	37.5	10.2	1.0	MKCP4T-450V256KEII
	35	18.5	1400	3.5	19	9.5	40	30x45x42	37.5	20.3	1.0	MKCP4T-450V356KGJI
	40	18.5	1600	3.5	21	9.5	40	30x55x42	37.5	20.3	1.0	MKCP4T-450V406KGLI
	40	13.5	800	6.0	19	11.0	20	25x45x57.5	52.5	10.2	1.2	MKCP4T-450V406KFJL
	50	15.5	1000	5.0	19	9.5	20	30x45x57.5	52.5	20.3	1.2	MKCP4T-450V506KGJL
	60	18.0	1200	4.5	20	8.0	20	35x50x57.5	52.5	20.3	1.2	MKCP4T-450V606KHKL
	70	19.0	1400	4.0	20	8.0	20	35x50x57.5	52.5	20.3	1.2	MKCP4T-450V706KHKL
	80	20.5	1600	3.5	21	8.0	20	35x50x57.5	52.5	20.3	1.2	MKCP4T-450V806KHKL
	85	20.5	1700	3.5	21	8.0	20	35x60x57.5	52.5	20.3	1.2	MKCP4T-450V856KHML
90	22.0	1800	3.0	21	8.0	20	35x60x57.5	52.5	20.3	1.2	MKCP4T-450V906KHML	
700 Vdc at 85 °C 800Vdc at 70 °C 500Vdc at 105 °C U_{TT} 1050Vdc/10s	15	10.5	600	8.0	18	13.0	40	21.5x38.5x43	37.5	10.2	1.0	MKCP4T-700V156KEHI
	20	12.5	800	6.0	19	12.0	40	24x44x42	37.5	10.2	1.0	MKCP4T-700V206KEII
	25	14.0	1000	5.5	30	11.0	40	28x42.5x42	37.5	10.2	1.0	MKCP4T-700V256KFII
		15.0	1000	5.0	19	9.5	40	30x45x42	37.5	20.3	1.0	MKCP4T-700V256KGJI
	30	17.0	1200	4.0	21	9.5	40	30x55x42	37.5	20.3	1.0	MKCP4T-700V306KGLI
		12.0	600	8.0	19	11.0	20	25x45x57.5	52.5	10.2	1.2	MKCP4T-700V306KFJL
	40	15.0	800	6.0	19	9.5	20	30x45x57.5	52.5	20.3	1.2	MKCP4T-700V406KGJL
	50	14.2	1000	5.5	20	9.5	20	30x45x57.5	52.5	20.3	1.2	MKCP4T-700V506KGJL
		17.0	1000	5.0	20	8.0	20	35x50x57.5	52.5	20.3	1.2	MKCP4T-700V506KHKL
	55	18.0	1100	4.5	20	8.0	20	35x50x57.5	52.5	20.3	1.2	MKCP4T-700V556KHKL
	70	20.5	1400	3.5	21	8.0	20	35x60x57.5	52.5	20.3	1.2	MKCP4T-700V706KHML
	80	21.5	1600	3.0	21	8.0	20	35x60x57.5	52.5	20.3	1.2	MKCP4T-700V806KHML
100	21.0	2000	4.0	35	7.0	20	60x45x57.5	52.5	20.3	1.2	MKCP4T-700V107KMJL	
120	22.5	2000	3.0	35	8.0	20	35x80x57.5	52.5	20.3	1.2	MKCP4T-700V127KHQLP	
900 Vdc at 85 °C 1100Vdc at 70 °C 650Vdc at 105 °C U_{TT} 1350Vdc/10s	9	8.5	360	12.5	18	13.0	40	21.5x38.5x43	37.5	10.2	1.0	MKCP4T-900V905KEHI
	12	10.0	480	9.0	19	12.0	40	24x44x42	37.5	10.2	1.0	MKCP4T-900V126KEII
	15	13.5	600	7.0	19	9.5	40	30x45x42	37.5	20.3	1.0	MKCP4T-900V156KGJI
	17	14.0	680	6.0	19	9.5	40	30x45x42	37.5	20.3	1.0	MKCP4T-900V176KGJI
	20	15.5	800	5.0	21	9.5	40	30x55x42	37.5	20.3	1.0	MKCP4T-900V206KGLI
		10.0	400	11.0	19	11.0	20	25x45x57.5	52.5	10.2	1.2	MKCP4T-900V206KFJL
	25	11.5	500	9.0	19	9.5	20	30x45x57.5	52.5	20.3	1.2	MKCP4T-900V256KGJL
	30	14.0	600	7.0	20	8.0	20	35x50x57.5	52.5	20.3	1.2	MKCP4T-900V306KHKL
	35	15.5	700	6.0	20	8.0	20	35x50x57.5	52.5	20.3	1.2	MKCP4T-900V356KHKL
40	16.5	800	5.0	21	8.0	20	35x60x57.5	52.5	20.3	1.2	MKCP4T-900V406KHML	

* additional information for I_r on page 54 and 61

Additional designs on request · Weitere Designs auf Anfrage

MKCP4T · PCB mount · 105 °C

Rated DC Voltage U_N derating Voltage test between terminals U_T	Nominal Capacitance C_N [μ F]	Ripple Current at 85 °C 1 k–10 kHz I_r^* [A RMS]	Peak Current Maximum value \hat{I} [A]	ESR [m Ω]	ESL [nH]	Thermal Resist. R_{th} [K/W]	dv/dt [V/ μ s]	Dimensions				Product Code
								Case Size $T \times H \times L$ [mm]		Terminals		
								P1 [mm]	P2 [mm]	$\varnothing d$ [mm]		
1100 Vdc at 85 °C 1300Vdc at 70 °C 800Vdc at 105 °C U_T 1650Vdc / 10s	5	7.5	225	16.0	18	13.0	45	21.5x38.5x43	37.5	10.2	1.0	MKCP4T-1100V505KEHI
	6	8.0	270	13.5	18	13.0	45	21.5x38.5x43	37.5	10.2	1.0	MKCP4T-1100V605KEHI
	8	10.0	360	10.0	19	12.0	45	24x44x42	37.5	10.2	1.0	MKCP4T-1100V805KEII
	12	13.5	540	6.5	19	9.5	45	30x45x42	37.5	20.3	1.0	MKCP4T-1100V126KGJI
	14	14.0	630	6.0	21	9.5	45	30x55x42	37.5	20.3	1.0	MKCP4T-1100V146KGLI
		9.5	320	11.5	19	11.0	23	25x45x57.5	52.5	10.2	1.2	MKCP4T-1100V146KFJL
	15	15.0	675	5.5	21	9.5	45	30x55x42	37.5	20.3	1.0	MKCP4T-1100V156KGLI
	18	11.5	410	9.0	19	9.5	23	30x45x57.5	52.5	20.3	1.2	MKCP4T-1100V186KGJL
	22	14.5	500	7.0	20	8.0	23	35x50x57.5	52.5	20.3	1.2	MKCP4T-1100V226KHKL
	25	15.0	570	6.5	20	8.0	23	35x50x57.5	52.5	20.3	1.2	MKCP4T-1100V256KHKL
	30	16.5	690	5.0	21	8.0	23	35x60x57.5	52.5	20.3	1.2	MKCP4T-1100V306KHML

* additional information for I_r on page 54 and 61

Additional designs on request · Weitere Designs auf Anfrage

> Life Time Table · Brauchbarkeitsdauer – Tabelle

Lifetime as function of ratio between the effective working voltage U_w and the rated DC voltage U_N													
$T_{HOTSPOT}$	x 0.5	x 0.6	x 0.7	x 0.75	x 0.8	x 0.85	x 0.9	x 0.95	x 1.0	x 1.05	x 1.1	x 1.15	x 1.20
50 °C	300	300	300	300	300	300	300	300	300	300	300	243	159
60 °C	300	300	300	300	300	300	300	300	300	300	189	121	79
70 °C	300	300	300	300	300	300	300	300	245	151	95	61	40
75 °C	300	300	300	300	300	300	300	290	175	106	67		
80 °C	300	300	300	300	300	300	300	205	123	76			
85 °C	300	300	300	300	300	300	249	145	87				
90 °C	300	300	300	247	148	148	91	57					
95 °C	300	300	192	119	76	49							
100 °C	300	112	48	33	23								
105 °C	46	22	12										

khrs value limited to 300 000 hours.

> Life Time Graph · Brauchbarkeitsdauer – Diagramm

Lifetime expectancy depending on hotspot temperature $T_{HOTSPOT}$ versus ratio between the effective working voltage U_w and the rated DC voltage U_N

Lebenserwartung in Abhängigkeit von der hotspot Temperatur $T_{HOTSPOT}$ und dem Verhältnis der tatsächlich anliegenden Spannung zur DC Nennspannung U_N

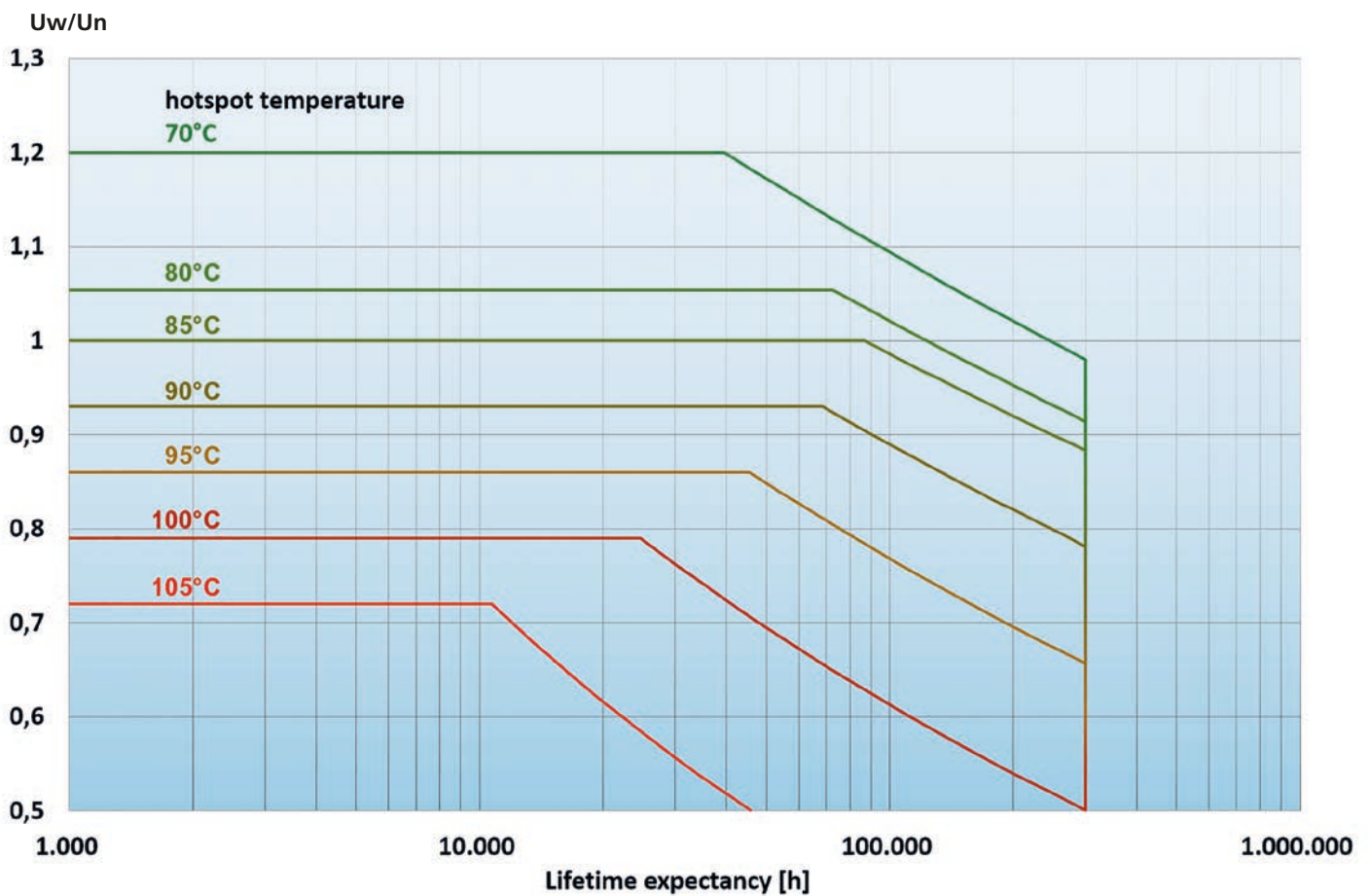

$$T_{HOTSPOT} = T_a + I^2 \times ESR \times R_{th}$$

> 95 % RH Lifetime comparison

Brauchbarkeitsdauer Vergleich bei 95 % relative Luftfeuchte

Example · Beispiel: MKCP4 vs. MKCP4T: $U_N=700\text{Vdc}$ at 85 °C

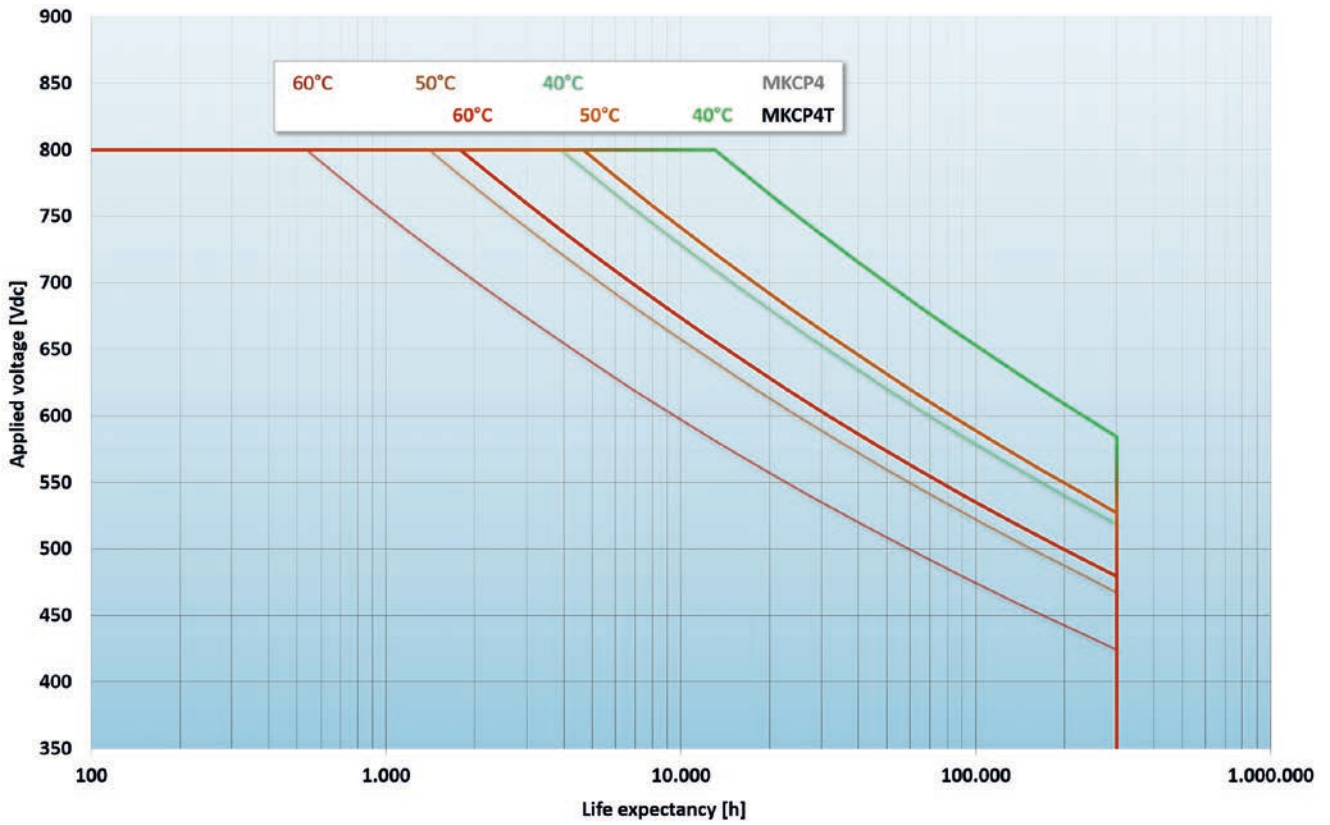

Example · Beispiel: MKCP4 vs. MKCP4T: $U_N=1100\text{Vdc}$ at 85 °C

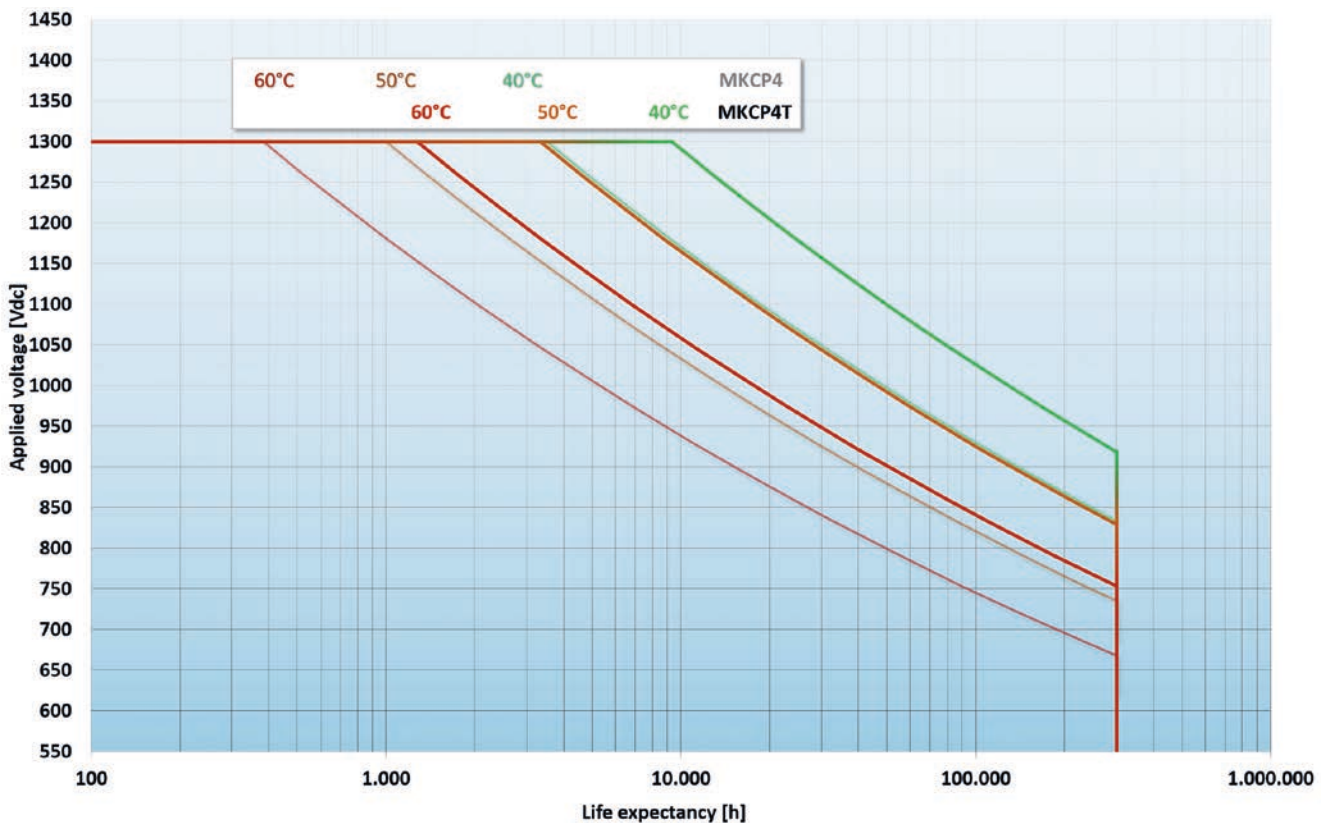

Handling Cautions

NOTES TO USERS OF PP FILM CAPACITORS

Before using the products, please read the notes for proper use.

1. Operating environment

- Water, salt water, oil, and other electro conductive liquid adhered to the capacitors may cause capacitor failure.
- Capacitors wetted with liquid must never not be operated.
- Capacitors must never be stored or operated in corrosive atmospheres, particularly not where chlorides, sulfides, acids, alkalis, salts, organic solvents or similar substances are present.
- Capacitors must not be operated in ozone or where ultra violet radiation or radioactive rays are irradiating.
- In dust and dirt-prone environments, regular checks and maintenance (particularly of the terminals and insulators) are absolutely necessary to prevent creation of creepage distances between live parts and/or the protective conductor/ground. Dust and dirt shall be cleaned with paper or towel wetted with ethanol, not detergent.
- Excessive vibration and/or shock may cause capacitor failure.

2. Operating conditions

2.1. Operating temperature, ripple current

- Capacitors must be operated according to the specification in catalog and/or data sheets.
- Overvoltage or thermal overload may cause rupture, ignition, and internal faults. When the highest temperature in capacitor is higher than 70°C, voltage derating has to be applied. For MLC and MLC2 series, permissible ripple current can be calculated from ambient temperature, operating voltage and information in data sheet or catalog.
 - Even if operating current is lower than permissible value, the current over permissible terminal current may cause excessive terminal heat generation.
- Ambient temperature is measured at point a point approximately 0.1 m away from the capacitor housing and at two-third of
 - the height from its base.
- It has to be noted that capacitors themselves generate heat.
- Permissible current decrease with the increase of ambient temperature. Therefore, it should be considered that capacitors must be selected by considering the operation at maximum ambient temperature.
- Frequency may affect electric load. Capacitors have to be selected by considering the effect of frequency.
- It should be noted that resonance by inductance of external circuit may affect capacitor's performance.
- It should be noted that parallel connection may cause current unbalance because of the difference of circuit impedance.
- Harmonics current may cause excessive heat generation because of dielectric loss at low frequency, or skin effect at high frequency. When harmonics current includes frequencies under 50Hz and/or over 10kHz components, the inner temperature of capacitors must be verified.
 - We recommend to check the following characteristics before proceeding evaluation. Please consult us for individual support if any of the following conditions apply.
 - Total current harmonic distortion based on the data computed exceed 200 %
 - Ratio between total current power losses and total dielectric power losses exceed 150 %
 - Capacitors with thermos sensor are not for endurance test, just for testing inner temperature rise. After the test, please scrap them.
 - The internal temperature should be measured after the inner temperature reached saturation (approx. five hours).

2.2. Applied voltage and other operating conditions

- Dielectric breakdown may cause severe internal fault such as short circuit, ignition and rupture. Capacitors must be operated inside the specified range specified in catalog and/or data sheets. For overvoltage within short period may not shorten service life time of capacitors.
- Capacitors must be operated under rated voltage. Surge voltage specified in data sheet is just for capacitor evaluation, and does not guarantee the continuous operation of capacitors.
- Inrush current may cause internal faults.
- Film capacitors have finite service life.
- DC capacitors must not be operated under AC condition. When ripple voltage over 20 % of rated voltage is applied to DC capacitors, it may cause capacitor failure. In this case, please contact us.

Handling Cautions

2.3. Cooling

- Give at least 40mm for MLC/MLC2 series or 20 mm for the others of clearance between the capacitors for natural or forced ventilation for effective heat dissipation of capacitors.

3. Before installation

3.1. Discharge

- AIC Europe GmbH and AIC tech Inc. does not accept responsibility for whatever damage may arise out of a non-observance, or caused by capacitors without agreement on detail of use condition, evaluation condition etc.
- In any event, the poles of the capacitors must be discharged with 1 kOhm or larger resistance before being touched.
- Note that capacitors with nominal voltages above 750Vac or 2,000Vdc in particular may regenerate new voltage at their terminals after having been short-circuited just for short periods. This condition will be avoided by storing them permanently short circuited.

3.2. Earthing

- Capacitors with a metal case must be earthed at the metal part or by means of a separate metal strap or clamp.

4. Mounting Location

4.1. Precaution

- Mechanically or electrically damaged, leaky or otherwise damaged capacitors may not be used or continue to be used.
- Do not place the capacitors directly above or nest to heat sources such as detuning or tuning reactors, bus bars, etc.
- Enough creepage distances and air clearance have to be kept when connecting capacitors, bus bars and housings.

4.2. Mounting

- Keep the torque described in catalog or data sheet. Toothed washer has to be used for fixing stud bolt.
- Three terminal type capacitors are equipped with Torx (T20). Use of improper screwdrivers may damage the screws and impair reliable fixation.
- Improper connection may cause local heat generation, and rupture and ignite. Don't apply excessive stress to terminals and stud bolt.
- The useful life of a capacitor may be reduced dramatically if exposed at excessive heat.
- The permitted max temperature of the capacitor must not be exceeded even under the most critical ambient circumstances.
- The inner temperature of capacitors must be verified not to exceed the maximum operating temperature specified in the data sheet at the worst operating condition.

Capacitors with thermos couple (PT100) are available depending of requests. Under force cooled condition, current over value specified in data sheet could be applied to capacitor. Please contact us when bus bars have high temperature and/or capacitors are placed with narrow space between them. They may cause increase in temperature of capacitors.

- It should be noted that the internal heat balance of large capacitors is only reached after a couple of hours when verifying inner temperature rise of capacitors.
- Capacitors with liquid or viscous filling shall be installed upright with terminals facing upwards. Capacitors with gas or solid resin filling can be mounted in any position without restriction.

4.3. Vibration / Shock

- Vibration and shock mainly affect fixing materials and terminals. It is important to measure the degree of vibration and shock at mounting location.
- The capacitors comply with test standard (IEC60068-2-6) as follows.

series	capacitor weight	test duration	frequency range	max. acceleration	max. displacement amplitude
MLC, MLC2, MLCA MKCP4, MKCP4T	< 3 kg 3 kg ≤	10 cycles per each axis	10 to 55Hz	50m/s ²	± 0.35 mm
information available on request					

5 Storage

5.1. Storage environment

- Ambient temperature : -40 °C to +35 °C
- Humidity : max. RH 75 % annual means
max. RH 95 % 30 days/year
- Capacitors may not be stored or operated outside the specified humidity ranges. Condensation is not permitted

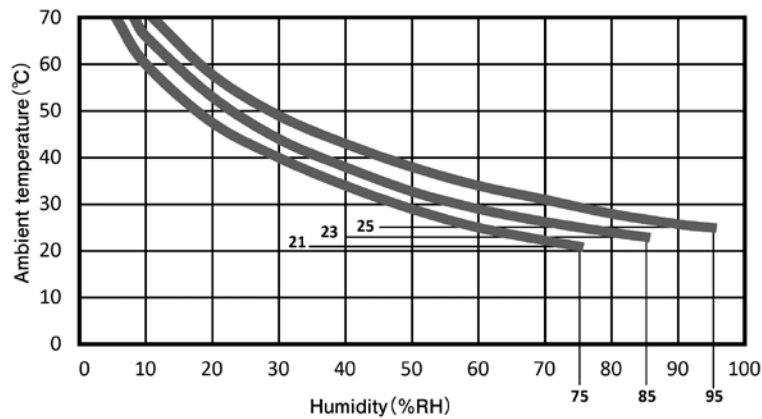

MLC / MLC2 / MLCA series

5.2. Storage limitation

- 2 years without any verifications
- When storage term is over two years, please confirm before usage that electric characteristics are within specifications, capacitor case is not covered with stains, and terminals are not covered with oxide layer.

6 Safety of self-healing type film capacitors

- In the event of a voltage breakdown the metal layers around the breakdown channel are evaporated by the temperature of the electric arc that forms between the electrodes. An insulation area is formed which is reliably resistive and voltage proof for all operating requirements of the capacitor. The capacitor remains fully functional during and after the breakdown.
- Surge voltages and surge currents within rated values induced by switching or faults of the system or any part of it are also permitted.

7 Mind hazards of explosion and fire

- Capacitors consist mainly of polypropylene, i.e. their energy content is relatively high. They may rupture and ignite as a result of internal faults or external overload (e.g. temperature, overvoltage, harmonic distortion).
- It must therefore be ensured, by appropriate measures, that they do not form any hazard to their environment in the event of failure or malfunction of the safety device.

8 Fumigation treatment

- Fumigation treatment may be performed during transportation for insect proofing.
- Halide such as methyl bromide may cause corrosion inside capacitors, and lead to failure. Insecticide also may cause capacitor failure.

9 Disposal

- We recommend disposing of the capacitors through professional recycling centers for electric/electronic waste.
- After incineration of capacitors, metal parts such as terminal, aluminum case, lid and internal wirings will be remained.
- Please consider that disposed capacitors should not put on the market.

10 Others

- In case of fire, dried powder, carbon dioxide or foam fire extinguishing agent has to be used.
- Please comply with transportation and exporting regulation in each nation.
- Capacitors usually have design life of approx. 15 to 20 years under proper operating condition. In order to maintain the reliability of equipment, it is recommended to replace the capacitors after ten years operation.



AIC EUROPE

Sales & technical support of **AIC** capacitors

AIC Europe GmbH

Adolf-Dembach-Straße 12
D-47829 Krefeld/Germany
E-Mail: info@aic-europe.com
Phone: +49 2151 4943-5
Fax: +49 2151 4943-80

www.aic-europe.com